



TRAFALGAR COREX

Trafalgar COREX is a lightweight, high impact resistant fire rated board designed to protect structural members.

Trafalgar COREX is quick to install, with reduced risk of applicator error, providing a robust and reliable method of steel fire protection.

**AS4100 compliant.
Including Regression
Analysis Data.**



KEY FEATURES



- High impact resistant
- Lightweight and sustainable product
- Score and snap like plasterboard
- Fire tested for all structural steel sections
- Fast installation using staples
- Regression data as per NCC & AS4100
- No separate metal framing is required
- Non-combustible
- Free technical advice

APPLICATIONS



- Steel structural fire proofing
 - Beams, columns, etc.
 - SHS, RHS, CHS
 - Angles, plates
 - Widest range of steel sizes
- Covering Hp/A up to 385m⁻¹
- Best approvals on the market

TRADES



TABLE OF CONTENTS



Content		Page
	Overview - Trafalgar COREX	1
	Benefits	3
	Structural Steel Fire Protection	4
	Steel Section Factor (Hp/A)	5
	System Approvals	6
Installation	Requirements	7
	Layout and Installation	8
	Board Offset Requirements	9
	Staple Fixing Requirements	10
FRL Tables	Thickness of Trafalgar COREX Required for FRL- Beams	11
	Thickness of Trafalgar COREX Required for FRL- Columns	12
	AS4100 Thickness Introduction	13
	Universal Columns- 550 Degrees	14
	Welded Columns- 550 Degrees	15
	Parallel Flange Columns- 550 Degrees	16
	Equal Angles- Columns- 550 Degrees	17
	Unequal Angles- Columns- 550 Degrees	18
	Square Hollow Sections- Columns- 550 Degrees	19
	Rectangular Hollow Sections- Columns- 550 Degrees	20
	Circular Hollow Section- Columns- 550 Degrees	21
	Universal Beams- 620 Degrees	22
	Welded Beams- 620 Degrees	23
	Parallel Flange Beams- 620 Degrees	24
	Product Range	25
	Safe Cutting, Working/Handling and Storage of Trafalgar COREX	26
	Compliance with the NCC	27
	Regression Coefficients	28
	FAQ	29
Appendix	Technical Drawings	30-44
	UL Greenguard Gold	45

TRAFALGAR COREX OVERVIEW

WHAT DOES IT DO?

Structural steel members often require fire protection to prevent collapse in the event of a fire. Under high heat, the material properties of the steel change, making collapse likely. To avoid this, the members can be clad in Trafalgar COREX to provide a fully compliant and fire tested thermal insulation barrier.

BENEFITS

Trafalgar COREX is a lightweight, impact resistant, high performance fire rated board designed to protect structural steel members.

APPROVED STEEL SECTIONS

- Beams
 - Universal Beam
 - Welded Beam
 - Tapered flange channel
 - Parallel flange channel
- Columns
 - Universal Column
 - Circular Hollow Section
 - Square Hollow Section
 - Rectangular Hollow Section
 - Equal Angle (and unequal angle)



For other sections not listed contact Trafalgar Fire at technical@tgroup.com.au.

PROFILE

PROPERTY	12.5mm THICK	15mm THICK	20mm THICK	25mm THICK
Length	2000mm			
Width	1200mm			
Average Weight	11.5kg/m ²	13.5kg/m ²	17.6kg/m ²	21.9kg/m ²
Weight per sheet	27.6kg	32.4kg	42.24kg	52.6kg
Flexural Strength (vertical)	≥725N	≥870N	≥1160N	≥1450N
Flexural Strength (horizontal)	≥300N	≥360N	≥450N	≥600N
Thermal Conductivity	0.25W/mK			

STRUCTURAL STEEL FIRE PROTECTION

While structural steel members do not directly contribute to the spread of fire, it is important to protect them. This is because under the heat of a fire the steel can start to lose its strength, which causes bending and twisting that can compound across a building, compromising the entire building's integrity. To avoid the potential collapse of a building, AS4100 dictates that structural steel members should be protected against the effect of fire, by limiting the heat rise of the structural member.

Depending on the site and building requirements, an FRL will be given for the steel members. This FRL will be, for example, 120/-/-. For structural steel the usual integrity and insulation criteria seen in the passive fire industry does not apply, instead only a structural adequacy figure is given (displayed in minutes).



This FRL given dictates the time that the steel member is required to remain under a certain critical temperature. This critical temperature is commonly accepted to be 550°C for columns and 620°C for beams. The factors that will determine how long a steel member can remain under this critical temperature are; the thickness and quality of the fire proofing material, and dimensions of the steel member.

FUNDAMENTALS OF STEEL PROTECTION



Thicker Steel = Easier to protect
(increased area = Lower H_p/A)



Thinner Steel = Harder to protect
(decreased area = Higher H_p/A)

H_p/A



Harder to protect

H_p/A



Easier to protect

Based on data from the fire testing (Refer to the compliance page on page 24 for details on how this is acquired), we can determine the thickness of material required to keep the steel member under the critical temperature for period of the given FRL, depending on the section factor of the member (see below for details on section factor).

STEEL SECTION FACTOR (HP/A)

The steel section factor is defined as the heated perimeter (H_p) divided by its cross-sectional area (A). For board materials this means the outside perimeter of the member that will be exposed to the fire (box section), divided by the cross-sectional area of the member. See below example.

Heated perimeter:

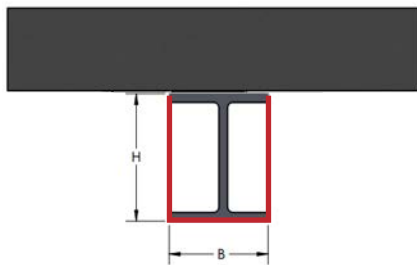

3 Sided Protection:
Heated Perimeter = $(2 \times H) + B$

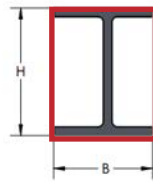

4 Sided Protection:
Heated Perimeter = $(2 \times H) + (2 \times B)$

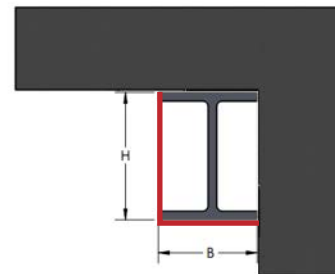

2 Sided Protection:
Heated Perimeter = $H + B$

Example:

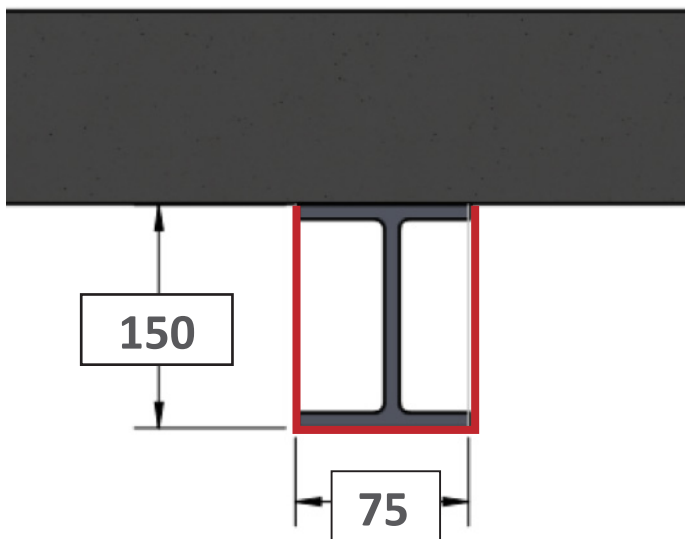

Take the beam to the left, for instance a 150UB (14).

The given cross-sectional area for this is 0.00173m².

3-sided protection would mean that the heated perimeter would be:

$$H_p = (2 \times H) + B \\ = 0.375\text{m}$$

Therefore,

$$H_p/A = 216.76$$

For convenience, a list of common beam and columns and their H_p/A values have been tabulated from page 11. If your steel section factor is not listed please contact Trafalgar Fire for assistance in calculating your required Trafalgar COREX thickness.

SYSTEM APPROVALS

Number	Items	Notes	Approval Report
1	Steel beams for up to 3 hours protection	Approved to AS4100 requirements for up to 180/-/- steel protection systems. Refer to installation steps and Hp/A tables on the following pages.	FAS200445
	Steel columns up to up to 3 hours protection		
	Hp/A values up to 385m-1		
	Hp/A values calculated for limiting temperatures between 350°C to 750°C		
2	3-sided encasements against steel ribbed decks (Bondek etc)	<p>Approved with rib voids sealed with:</p> <ul style="list-style-type: none"> - Less than 40mm wide with FyreFLEX sealant - Greater than 40mm wide with FyreBATT, or - Trafalgar COREX face fixed over deck for 300mm on both sides, bolted to the soffit <p>Refer to drawings from page 7 for more details.</p>	
3	3-sided encasements along edge of slab	Approved as per drawings on page 7	
4	Coat-back to secondary steel members	Approved 500mm coat-back to the secondary steel members.	FAS210135
5	Trafalgar COREX board interfaces between spray and intumescent paints	<p>Approved:</p> <ul style="list-style-type: none"> - Spray system: 100mm overlaps to the Trafalgar COREX and visa versa - Intumescent Paints: No overlap, just FyreFLEX Sealant fillet to the interface <p>Refer to drawings on page 7</p>	



INSTALLATION



IDENTIFY STEEL TYPE AND SIZE

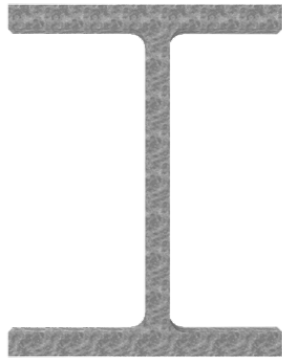

DETERMINE THE FRL



For other temperature ratings, or assistance calculating the H_p/A of the structural member, contact technical@tgroup.com.au.



DETERMINE TRAFALGAR COREX THICKNESS

STEEL SIZE	THICKNESS OF COREX																				
	Hp/A	4 SIDED ENCASUREMENT				3 SIDED ENCASUREMENT				2 SIDED ENCASUREMENT				1 SIDED ENCASUREMENT							
		1/m	60	90	120	180	1/m	60	90	120	180	1/m	60	90	120	180	1/m	60	90	120	180
500WC	440	35	12.5	12.5	12.5	20	30	12.5	12.5	12.5	15	20	12.5	12.5	12.5	12.5	10	12.5	12.5	12.5	12.5
	404	40	12.5	12.5	12.5	25	30	12.5	12.5	12.5	15	20	12.5	12.5	12.5	12.5	10	12.5	12.5	12.5	12.5
	383	40	12.5	12.5	12.5	25	30	12.5	12.5	12.5	15	20	12.5	12.5	12.5	12.5	15	12.5	12.5	12.5	12.5
	340	50	12.5	12.5	12.5	15H45	35	12.5	12.5	12.5	20	25	12.5	12.5	12.5	12.5	15	12.5	12.5	12.5	12.5
	280	55	12.5	12.5	15	15H45	45	12.5	12.5	12.5	25	30	12.5	12.5	12.5	15	15	12.5	12.5	12.5	12.5
400WC	267	60	12.5	12.5	20	20H45	45	12.5	12.5	12.5	25	30	12.5	12.5	12.5	15	15	12.5	12.5	12.5	12.5
	228	70	12.5	12.5	20	20H45	55	12.5	12.5	15	15H45	35	12.5	12.5	12.5	20	20	12.5	12.5	12.5	12.5
	361	40	12.5	12.5	12.5	25	30	12.5	12.5	12.5	15	20	12.5	12.5	12.5	12.5	10	12.5	12.5	12.5	12.5
	328	40	12.5	12.5	12.5	25	30	12.5	12.5	12.5	15	20	12.5	12.5	12.5	12.5	10	12.5	12.5	12.5	12.5
	303	45	12.5	12.5	12.5	25	35	12.5	12.5	12.5	20	25	12.5	12.5	12.5	12.5	15	12.5	12.5	12.5	12.5
350WC	270	50	12.5	12.5	12.5	15H45	35	12.5	12.5	12.5	20	25	12.5	12.5	12.5	12.5	15	12.5	12.5	12.5	12.5
	242	60	12.5	12.5	20	20H45	45	12.5	12.5	12.5	25	30	12.5	12.5	12.5	15	15	12.5	12.5	12.5	12.5
	181	70	12.5	12.5	20	20H45	55	12.5	12.5	15	15H45	35	12.5	12.5	12.5	20	20	12.5	12.5	12.5	12.5
	144	85	12.5	15	25	20H45	65	12.5	12.5	20	20H45	40	12.5	12.5	12.5	25	25	12.5	12.5	12.5	12.5
	280	40	12.5	12.5	12.5	25	30	12.5	12.5	12.5	15	20	12.5	12.5	12.5	12.5	10	12.5	12.5	12.5	12.5
350WC	250	45	12.5	12.5	12.5	25	35	12.5	12.5	12.5	20	25	12.5	12.5	12.5	12.5	15	12.5	12.5	12.5	12.5
	200	60	12.5	12.5	12.5	15H45	35	12.5	12.5	12.5	20	25	12.5	12.5	12.5	12.5	15	12.5	12.5	12.5	12.5
187	55	12.5	12.5	15	15H45	40	12.5	12.5	12.5	25	30	12.5	12.5	12.5	15	15	12.5	12.5	12.5	12.5	

Find the required thickness of Trafalgar COREX from the tables from page 11 onwards.





CHECK FOR SINGLE OR DOUBLE LAYER

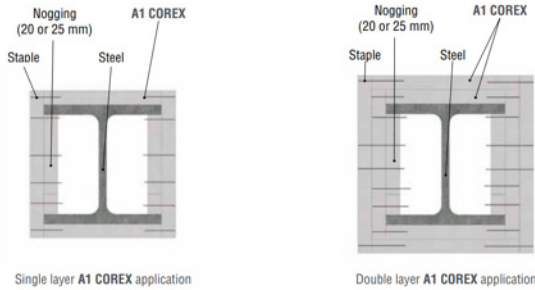

Refer to diagrams on page 8 to determine relevant encasement layout, for single or double-layer encasement. For 3-sided applications please refer to the drawings at the end of this manual.



NOGGINGS

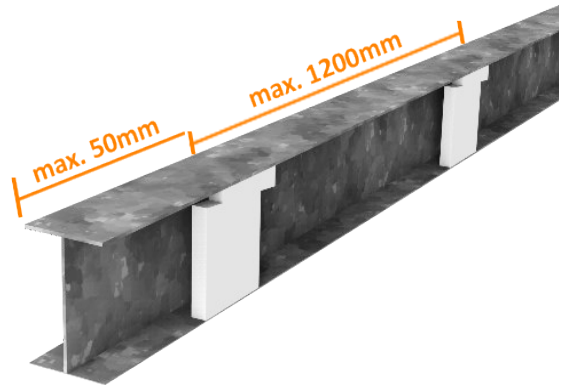

Open profile members require 20mm thick Trafalgar COREX Noggings to be installed at maximum 1200mm centers. Each Nogging should be a minimum 120mm wide, and 3mm longer than the internal height of the member. Cut at an angle through the nogging allowing a wedge to be hammered into place, securing the nogging. The distance from the first nogging to the end of the beam should be not more than 50mm.

COREX Board can be scored and snapped, or cut with hand saws or power saws



FIXING AT NOGGINGS

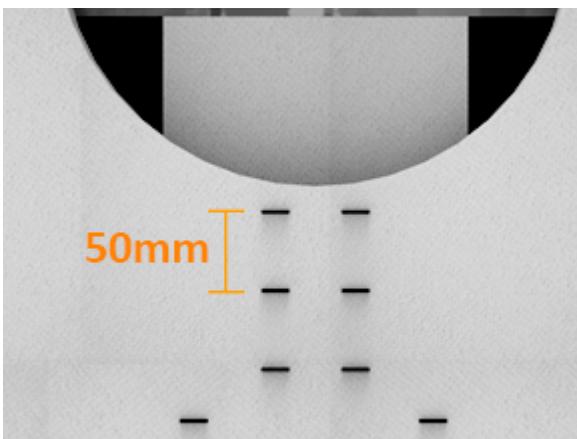

Fix using staples outlined in page 9 through the Trafalgar COREX, into the Nogging. Staples to be installed a 50mm centers vertically. Staples should be flush with the surface of the Trafalgar COREX. Confirm setting of the stapling machine before you start stapling.



FIXING BOARD TO BOARD

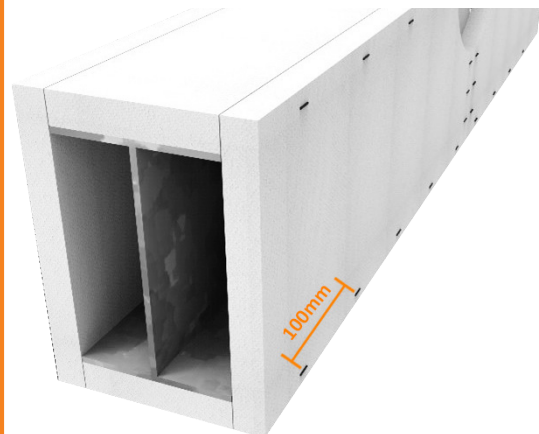

Fix staples at 100mm centers. Staples should be flush with the surface of the Trafalgar COREX. Confirm & trial settings of the stapling machine before you start stapling.



ENSURE CORRECT OFFSET (1-LAYER SYSTEM ONLY)



Joins in layers on adjacent sides must be offset by 300mm (refer to image).



FIT AND FIX SECOND LAYER (2-LAYERS SYSTEM ONLY)

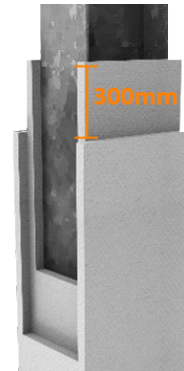

Repeat the previous steps to ensure the second layer of Trafalgar COREX is fixed at the correct intervals. For two-layer encasements, ensure to offset each join in different layers by a minimum of 300mm (refer to image).

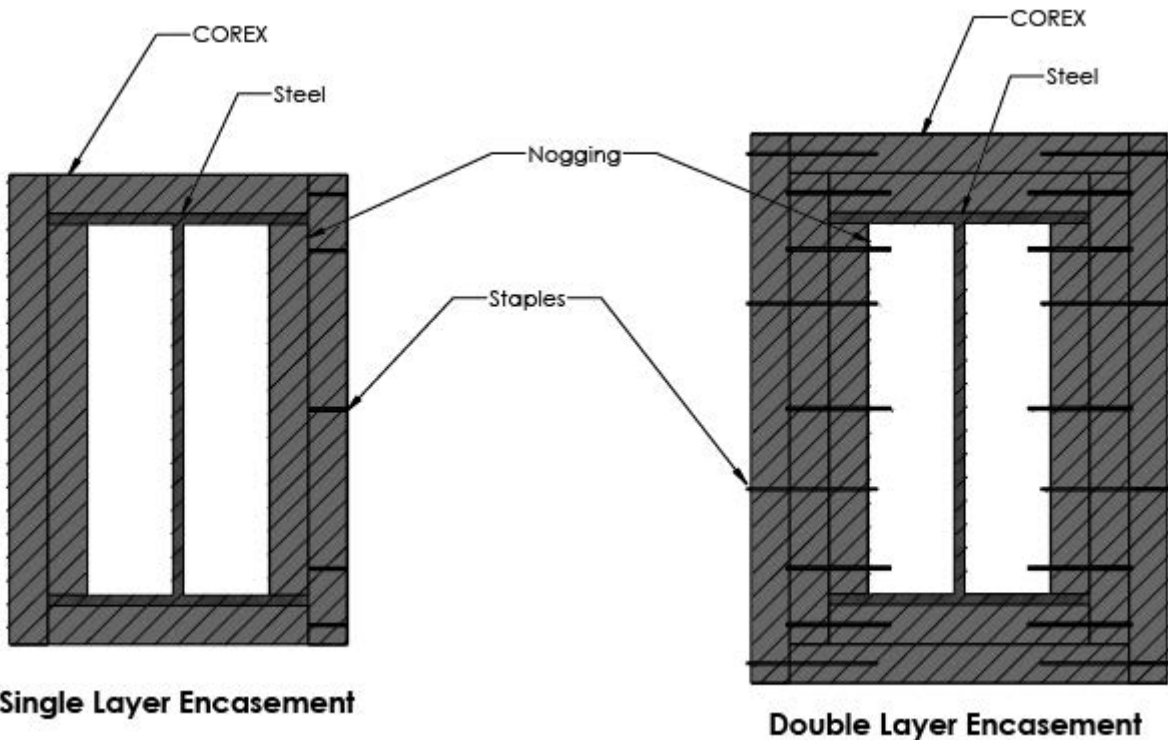

Single Layer Encasement

Double Layer Encasement

For 3-sided encasement of steel against concrete/masonry elements please refer to the drawings at the end of this manual for installation diagrams.

STAPLE FIXING REQUIREMENTS

Staples are required at 100mm centres along the length of the board, and at 50mm centres across the noggings. If a two-layer system is installed, ensure the joins in the board are staggered from the first layer.

Board Thickness (mm)	Staple Length (mm)	Spacing (mm)
12.5	40 or 50	100 (plus 50 along noggling)
15	40 or 50	100 (plus 50 along noggling)
20	40 or 50	100 (plus 50 along noggling)
25	40 or 50	100 (plus 50 along noggling)
30	40 or 50	100 (plus 50 along noggling)
35	50	100 (plus 50 along noggling)
40	50	100 (plus 50 along noggling)

Please note: The orientation of the joins will not effect the system, I.E Staples can run along the flange or the beam

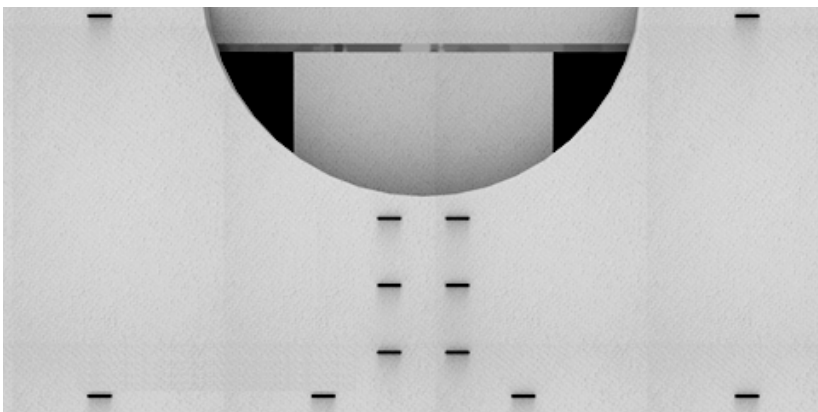

Fixing spacing requirements.

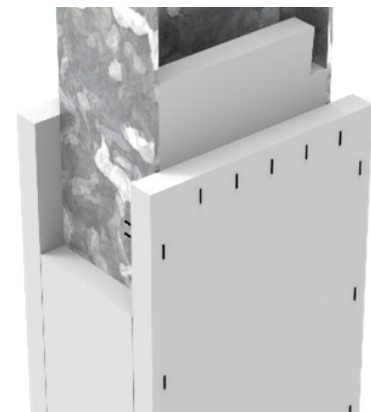

Board joins staggered.

FRL Approvals Tables

THICKNESS OF TRAFALGAR COREX REQUIRED FOR FRL

Determine the required Hp/A from the above tables (or manual calculations) then refer to the below tables to acquire the necessary thickness of Trafalgar COREX. Structural Steel Beams typically have a typical critical temperature rating of 620 degrees, the following tables reflect this requirement, for other critical temperatures please contact Trafalgar for assistance.

For thickness less than 25mm, a double layer system can be used. Contact Trafalgar for details.

Beams - Structural I/H Beams (620°)

HP/A	SINGLE LAYER SYSTEMS TIME					DOUBLE LAYER SYSTEMS TIME				
	30 min	60 MIN	90 MIN	120 MIN	180 MIN	30 min	60 MIN	90 MIN	120 MIN	180 MIN
50	12.5	12.5	12.5	12.5	25	-	-	-	12.5+12.5	15+12.5
60	12.5	12.5	12.5	12.5	-	-	-	-	12.5+12.5	15+15
70	12.5	12.5	12.5	15	-	-	-	-	12.5+12.5	20+12.5
80	12.5	12.5	12.5	20	-	-	-	-	12.5+12.5	20+15
90	12.5	12.5	12.5	20	-	-	-	-	12.5+12.5	20+15
100	12.5	12.5	15	25	-	-	-	-	12.5+12.5	25+12.5
110	12.5	12.5	15	25	-	-	-	-	15+12.5	25+12.5
120	12.5	12.5	15	25	-	-	-	-	15+12.5	20+20
130	12.5	12.5	20	25	-	-	-	-	15+12.5	20+20
140	12.5	12.5	20	-	-	-	-	-	15+15	20+25
150	12.5	12.5	20	-	-	-	-	-	15+15	20+25
160	12.5	12.5	20	-	-	-	-	-	15+15	20+25
170	12.5	12.5	20	-	-	-	-	-	15+15	20+25
180	12.5	12.5	20	-	-	-	-	-	15+15	20+25
190	12.5	12.5	20	-	-	-	-	-	15+15	20+25
200	12.5	12.5	25	-	-	-	-	-	20+12.5	20+25
210	12.5	12.5	25	-	-	-	-	-	20+12.5	20+25
220	12.5	12.5	25	-	-	-	-	-	20+12.5	20+25
230	12.5	12.5	25	-	-	-	-	-	20+12.5	20+25
240	12.5	12.5	25	-	-	-	-	-	20+12.5	20+25
250	12.5	12.5	25	-	-	-	-	-	20+12.5	20+25
260	12.5	15	25	-	-	-	-	12.5+12.5	20+12.5	-
270	12.5	15	25	-	-	-	-	15+12.5	20+12.5	-
280	12.5	15	25	-	-	-	-	15+12.5	20+12.5	-
290	12.5	15	25	-	-	-	-	15+12.5	20+12.5	-
300	12.5	15	25	-	-	-	-	15+12.5	20+15	-
310	12.5	15	25	-	-	-	-	15+12.5	20+15	-
320	12.5	15	25	-	-	-	-	15+12.5	20+15	-
330	12.5	15	25	-	-	-	-	15+12.5	20+15	-
340	12.5	15	25	-	-	-	-	15+12.5	20+15	-
350	12.5	15	25	-	-	-	-	15+12.5	20+15	-
360	12.5	15	25	-	-	-	-	15+12.5	20+15	-
370	12.5	15	25	-	-	-	-	15+12.5	20+15	-
380	12.5	15	25	-	-	-	-	15+12.5	20+15	-
385	12.5	15	25	-	-	-	-	15+12.5	20+15	-

*For other critical temperatures, encasement types, and non-standard steel members, contract technical@tgroup.com.au.

FRL Approvals Tables

THICKNESS OF TRAFALGAR COREX REQUIRED FOR FRL

Structural Steel Columns typically have a typical critical temperature rating of 550 degrees, the following tables reflect this requirement, for other critical temperatures please contact Trafalgar for assistance.

For thickness less than 25mm, a double layer system can be used. Contact Trafalgar for details.

Columns - Structural I/H Columns, & Round/Rectangular/Circular Hollow (550°)

HP/A	SINGLE LAYER SYSTEMS TIME					DOUBLE LAYER SYSTEMS TIME				
	30 min	60 MIN	90 MIN	120 MIN	180 MIN	30 min	60 MIN	90 MIN	120 MIN	180 MIN
50	12.5	12.5	12.5	12.5	-	-	-	-	-	15+15
60	12.5	12.5	12.5	20	-	-	-	-	-	20+12.5
70	12.5	12.5	12.5	20	-	-	-	-	-	20+15
80	12.5	12.5	15	25	-	-	-	-	-	25+12.5
90	12.5	12.5	15	25	-	-	-	-	15+12.5	25+12.5
100	12.5	12.5	20	25	-	-	-	-	15+12.5	20+20
110	12.5	12.5	20	-	-	-	-	-	15+15	20+20
120	12.5	12.5	20	-	-	-	-	-	15+15	20+25
130	12.5	12.5	20	-	-	-	-	-	15+15	20+25
140	12.5	12.5	20	-	-	-	-	-	15+15	20+25
150	12.5	12.5	25	-	-	-	-	-	20+12.5	20+25
160	12.5	12.5	25	-	-	-	-	-	20+12.5	20+25
170	12.5	12.5	25	-	-	-	-	-	20+12.5	20+25
180	12.5	15	25	-	-	-	-	15+12.5	20+12.5	-
190	12.5	15	25	-	-	-	-	15+12.5	20+12.5	-
200	12.5	15	25	-	-	-	-	15+12.5	20+15	-
210	12.5	15	25	-	-	-	-	15+12.5	20+15	-
220	12.5	15	25	-	-	-	-	15+12.5	20+15	-
230	12.5	15	25	-	-	-	-	15+12.5	20+15	-
240	12.5	15	25	-	-	-	-	15+12.5	20+15	-
250	12.5	15	25	-	-	-	-	15+12.5	20+15	-
260	12.5	20	-	-	-	-	-	15+12.5	20+15	-
270	12.5	20	-	-	-	-	-	15+12.5	20+15	-
280	12.5	20	-	-	-	-	-	15+15	20+15	-
290	12.5	20	-	-	-	-	-	15+15	20+15	-
300	12.5	20	-	-	-	-	-	15+15	20+15	-
310	12.5	20	-	-	-	-	-	15+15	25+12.5	-
320	12.5	20	-	-	-	-	-	15+15	25+12.5	-
330	12.5	20	-	-	-	-	-	15+15	25+12.5	-
340	12.5	20	-	-	-	-	-	15+15	25+12.5	-
350	12.5	20	-	-	-	-	-	15+15	25+12.5	-
360	12.5	20	-	-	-	-	-	15+15	25+12.5	-
370	12.5	20	-	-	-	-	-	15+15	25+12.5	-
380	12.5	20	-	-	-	-	-	15+15	25+12.5	-
385	12.5	20	-	-	-	-	-	15+15	25+12.5	-

*For other critical temperatures, encasement types, and non-standard steel members, contact technical@tgroup.com.au.



TRAFALGAR COREX THICKNESS FOR COMMON STEEL TYPES AND APPLICATIONS AS4100

Note: Columns are calculated at 550°C critical temp, and
Beams are calculated at 620°C critical temp.

For other critical temperatures contact technical@tgroup.com.au.

This manual can change at anytime without notice.

Please validate data with your the structural engineer for critical temperatures & fire requirements.

UNIVERSAL COLUMNS

(550 Degrees Critical Temperature)

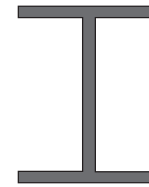

THICKNESS OF TRAFALGAR COREX

STEEL SIZE	4 SIDED ENCASEMENT						3 SIDED ENCASEMENT					2 SIDED ENCASEMENT					1 SIDED ENCASEMENT				
	Hp/A	FIRE RESISTANCE LEVELS					Hp/A	FIRE RESISTANCE LEVELS				Hp/A	FIRE RESISTANCE LEVELS				Hp/A	FIRE RESISTANCE LEVELS			
	1/m	60	90	120	180	1/m	60	90	120	180	1/m	60	90	120	180	1/m	60	90	120	180	
310UC	283	40	12.5	12.5	12.5	25	30	12.5	12.5	12.5	15	20	12.5	12.5	12.5	12.5	10	12.5	12.5	12.5	12.5
	240	45	12.5	12.5	12.5	25	35	12.5	12.5	12.5	20	20	12.5	12.5	12.5	12.5	15	12.5	12.5	12.5	12.5
	198	50	12.5	12.5	12.5	15+15	40	12.5	12.5	12.5	25	25	12.5	12.5	12.5	12.5	15	12.5	12.5	12.5	12.5
	158	65	12.5	12.5	20	20+15	50	12.5	12.5	12.5	15+15	30	12.5	12.5	12.5	15	15	12.5	12.5	12.5	12.5
	137	70	12.5	12.5	20	20+15	55	12.5	12.5	15	15+15	35	12.5	12.5	12.5	20	20	12.5	12.5	12.5	12.5
	118	85	12.5	15	25	25+12.5	60	12.5	12.5	20	20+12.5	40	12.5	12.5	12.5	25	20	12.5	12.5	12.5	12.5
	97	100	12.5	20	25	20+20	75	12.5	12.5	20	20+15	50	12.5	12.5	12.5	15+15	25	12.5	12.5	12.5	12.5
250UC	90	90	12.5	15	25	25+12.5	70	12.5	12.5	20	20+15	45	12.5	12.5	12.5	25	25	12.5	12.5	12.5	12.5
	73	110	12.5	20	15+15	20+20	80	12.5	15	25	25+12.5	55	12.5	12.5	15	15+15	30	12.5	12.5	12.5	15
200UC	60	110	12.5	20	15+15	20+20	80	12.5	15	25	25+12.5	55	12.5	12.5	15	15+15	30	12.5	12.5	12.5	15
	52	125	12.5	20	15+15	20+25	95	12.5	20	25	20+20	60	12.5	12.5	20	20+12.5	35	12.5	12.5	12.5	20
	46	140	12.5	20	15+15	20+25	105	12.5	20	25	20+20	70	12.5	12.5	20	20+15	35	12.5	12.5	12.5	20
150UC	37	135	12.5	20	15+15	20+25	100	12.5	20	25	20+20	65	12.5	12.5	20	20+15	35	12.5	12.5	12.5	20
	30	160	12.5	25	20+12.5	20+25	120	12.5	20	15+15	20+25	80	12.5	15	25	25+12.5	40	12.5	12.5	12.5	25
	23	205	15	25	20+15	-	155	12.5	25	20+12.5	20+25	100	12.5	20	25	20+20	55	12.5	12.5	15	15+15
100UC	15	210	15	25	20+15	-	160	12.5	25	20+12.5	20+25	105	12.5	20	25	20+20	55	12.5	12.5	15	15+15

*For other critical temperatures, encasement types, and non-standard steel members, contract technical@tgroup.com.au.

WELDED COLUMNS

(550 Degrees Critical Temperature)

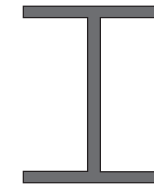

THICKNESS OF TRAFALGAR COREX

STEEL SIZE	4 SIDED ENCASUREMENT						3 SIDED ENCASUREMENT					2 SIDED ENCASUREMENT					1 SIDED ENCASUREMENT				
	Hp/A	FIRE RESISTANCE LEVELS					Hp/A	FIRE RESISTANCE LEVELS				Hp/A	FIRE RESISTANCE LEVELS				Hp/A	FIRE RESISTANCE LEVELS			
	1/m	60	90	120	180	1/m	60	90	120	180	1/m	60	90	120	180	1/m	60	90	120	180	
500WC	440	35	12.5	12.5	12.5	20	30	12.5	12.5	12.5	15	20	12.5	12.5	12.5	12.5	10	12.5	12.5	12.5	12.5
	414	40	12.5	12.5	12.5	25	30	12.5	12.5	12.5	15	20	12.5	12.5	12.5	12.5	10	12.5	12.5	12.5	12.5
	383	40	12.5	12.5	12.5	25	30	12.5	12.5	12.5	15	20	12.5	12.5	12.5	12.5	15	12.5	12.5	12.5	12.5
	340	50	12.5	12.5	12.5	15+15	35	12.5	12.5	12.5	20	25	12.5	12.5	12.5	12.5	15	12.5	12.5	12.5	12.5
	290	55	12.5	12.5	15	15+15	45	12.5	12.5	12.5	25	30	12.5	12.5	12.5	15	15	12.5	12.5	12.5	12.5
	267	60	12.5	12.5	20	20+12.5	45	12.5	12.5	12.5	25	30	12.5	12.5	12.5	15	15	12.5	12.5	12.5	12.5
	228	70	12.5	12.5	20	20+15	55	12.5	12.5	15	15+15	35	12.5	12.5	12.5	20	20	12.5	12.5	12.5	12.5
400WC	361	40	12.5	12.5	12.5	25	30	12.5	12.5	12.5	15	20	12.5	12.5	12.5	12.5	10	12.5	12.5	12.5	12.5
	328	40	12.5	12.5	12.5	25	30	12.5	12.5	12.5	15	20	12.5	12.5	12.5	12.5	10	12.5	12.5	12.5	12.5
	303	45	12.5	12.5	12.5	25	35	12.5	12.5	12.5	20	25	12.5	12.5	12.5	12.5	15	12.5	12.5	12.5	12.5
	270	50	12.5	12.5	12.5	15+15	35	12.5	12.5	12.5	20	25	12.5	12.5	12.5	12.5	15	12.5	12.5	12.5	12.5
	212	60	12.5	12.5	20	20+12.5	45	12.5	12.5	12.5	25	30	12.5	12.5	12.5	15	15	12.5	12.5	12.5	12.5
	181	70	12.5	12.5	20	20+15	55	12.5	12.5	15	15+15	35	12.5	12.5	12.5	20	20	12.5	12.5	12.5	12.5
	144	85	12.5	15	25	25+12.5	65	12.5	12.5	20	20+15	40	12.5	12.5	12.5	25	25	12.5	12.5	12.5	12.5
350WC	280	40	12.5	12.5	12.5	25	30	12.5	12.5	12.5	15	20	12.5	12.5	12.5	12.5	10	12.5	12.5	12.5	12.5
	258	45	12.5	12.5	12.5	25	35	12.5	12.5	12.5	20	25	12.5	12.5	12.5	12.5	15	12.5	12.5	12.5	12.5
	230	50	12.5	12.5	12.5	15+15	35	12.5	12.5	12.5	20	25	12.5	12.5	12.5	12.5	15	12.5	12.5	12.5	12.5
	197	55	12.5	12.5	15	15+15	40	12.5	12.5	12.5	25	30	12.5	12.5	12.5	15	15	12.5	12.5	12.5	12.5

*For other critical temperatures, encasement types, and non-standard steel members, contract technical@tgroup.com.au.

PARALLEL FLANGE COLUMNS (550 Degrees Critical Temperature)



THICKNESS OF TRAFALGAR COREX

STEEL SIZE	4 SIDED ENCASUREMENT					3 SIDED ENCASUREMENT					2 SIDED ENCASUREMENT					1 SIDED ENCASUREMENT				
	Hp/A	FIRE RESISTANCE LEVELS				Hp/A	FIRE RESISTANCE LEVELS				Hp/A	FIRE RESISTANCE LEVELS				Hp/A	FIRE RESISTANCE LEVELS			
	1/m	60	90	120	180	1/m	60	90	120	180	1/m	60	90	120	180	1/m	60	90	120	180
380PFC	140	12.5	20	15+15	20+25	125	12.5	20	15+15	20+25	70	12.5	12.5	20	20+15	15	12.5	12.5	12.5	12.5
300PFC	157	12.5	25	20+12.5	20+25	139	12.5	20	15+15	20+25	78	12.5	12.5	25	25+12.5	18	12.5	12.5	12.5	12.5
250PFC	154	12.5	25	20+12.5	20+25	134	12.5	20	15+15	20+25	77	12.5	12.5	25	25+12.5	20	12.5	12.5	12.5	12.5
230PFC	196	15	25	20+15	-	172	12.5	25	20+12.5	20+25	98	12.5	20	25	20+20	24	12.5	12.5	12.5	12.5
200PFC	193	15	25	20+12.5	-	167	12.5	25	20+12.5	20+25	97	12.5	20	25	20+20	26	12.5	12.5	12.5	12.5
180PFC	196	15	25	20+15	-	168	12.5	25	20+12.5	20+25	98	12.5	20	25	20+20	29	12.5	12.5	12.5	12.5
150PFC	205	15	25	20+15	-	171	12.5	25	20+12.5	20+25	102	12.5	20	25	20+20	34	12.5	12.5	12.5	20
125 PFC	257	20	15+12.5	20+15	-	213	15	25	20+15	-	129	12.5	20	15+15	20+25	44	12.5	12.5	12.5	25
100 PFC	290	20	15+15	20+15	-	242	15	25	20+15	-	145	12.5	25	20+12.5	20+25	48	12.5	12.5	12.5	25
75 PFC	313	20	15+15	25+12.5	-	258	20	15+12.5	20+15	-	156	12.5	25	20+12.5	20+25	54	12.5	12.5	15	15+15

*For other critical temperatures, encasement types, and non-standard steel members, contract technical@tgroup.com.au.

EQUAL ANGLES - COLUMNS

(550 Degrees Critical Temperature)

Click here to go back to Contents

THICKNESS - EQUAL ANGLES

THICKNESS OF TRAFALGAR COREX

STEEL SIZE	4 SIDED ENCASEMENT						3 SIDED ENCASEMENT					2 SIDED ENCASEMENT					1 SIDED ENCASEMENT							
	Hp/A	FIRE RESISTANCE LEVELS					Hp/A	FIRE RESISTANCE LEVELS					Hp/A	FIRE RESISTANCE LEVELS					Hp/A	FIRE RESISTANCE LEVELS				
	1/m	60	90	120	180	1/m	60	90	120	180	1/m	60	90	120	180	1/m	60	90	120	180				
200x200	26EA	85	12.5	15	25	25+12.5	65	12.5	12.5	20	20+15	42	12.5	12.5	12.5	25	21	12.5	12.5	12.5	12.5			
	20EA	107	12.5	20	15+15	20+20	80	12.5	15	25	25+12.5	54	12.5	12.5	15	15+15	27	12.5	12.5	12.5	12.5			
	18EA	118	12.5	20	15+15	20+25	89	12.5	15	25	25+12.5	59	12.5	12.5	20	20+12.5	30	12.5	12.5	12.5	15			
	16EA	132	12.5	20	15+15	20+25	99	12.5	20	25	20+20	66	12.5	12.5	20	20+15	33	12.5	12.5	12.5	20			
	13EA	161	12.5	25	20+12.5	20+25	121	12.5	20	15+15	20+25	81	12.5	15	25	25+12.5	40	12.5	12.5	12.5	25			
150x150	19EA	115	12.5	20	15+15	20+25	86	12.5	15	25	25+12.5	57	12.5	12.5	15	20+12.5	29	12.5	12.5	12.5	12.5			
	16EA	136	12.5	20	15+15	20+25	102	12.5	20	25	20+20	68	12.5	12.5	20	20+15	34	12.5	12.5	12.5	20			
	12EA	177	15	25	20+12.5	-	133	12.5	20	15+15	20+25	88	12.5	15	25	25+12.5	44	12.5	12.5	12.5	25			
	10EA	221	15	25	20+15	-	165	12.5	25	20+12.5	20+25	110	12.5	20	15+15	20+20	55	12.5	12.5	15	15+15			
125x125	16EA	138	12.5	20	15+15	20+25	104	12.5	20	25	20+20	69	12.5	12.5	20	20+15	35	12.5	12.5	12.5	20			
	12EA	179	15	25	20+12.5	-	134	12.5	20	15+15	20+25	89	12.5	15	25	25+12.5	45	12.5	12.5	12.5	25			
	10EA	224	15	25	20+15	-	168	12.5	25	20+12.5	20+25	112	12.5	20	15+15	20+25	56	12.5	12.5	15	20+12.5			
	8EA	270	20	15+12.5	20+15	-	203	15	25	20+15	-	135	12.5	20	15+15	20+25	68	12.5	12.5	20	20+15			
100x100	12EA	182	15	25	20+12.5	-	136	12.5	20	15+15	20+25	91	12.5	15	25	20+20	45	12.5	12.5	12.5	25			
	10EA	227	15	25	20+15	-	170	12.5	25	20+12.5	20+25	113	12.5	20	15+15	20+25	57	12.5	12.5	15	20+12.5			
	8EA	273	20	15+12.5	20+15	-	205	15	25	20+15	-	136	12.5	20	15+15	20+25	68	12.5	12.5	20	20+15			
	6EA	352	20	15+15	25+12.5	-	264	20	15+12.5	20+15	-	176	12.5	25	20+12.5	20+25	88	12.5	15	25	25+12.5			
90x90	10EA	228	15	25	20+15	-	171	12.5	25	20+12.5	20+25	114	12.5	20	15+15	20+25	57	12.5	12.5	15	20+12.5			
	8EA	273	20	15+12.5	20+15	-	205	15	25	20+15	-	137	12.5	20	15+15	20+25	68	12.5	12.5	20	20+15			
	6EA	353	20	15+15	25+12.5	-	264	20	15+12.5	20+15	-	176	12.5	25	20+12.5	20+25	88	12.5	15	25	25+12.5			
75x75	10EA	230	15	25	20+15	-	173	12.5	25	20+12.5	20+25	115	12.5	20	15+15	20+25	58	12.5	12.5	20	20+12.5			
	8EA	277	20	15+15	20+15	-	207	15	25	20+15	-	138	12.5	20	15+15	20+25	69	12.5	12.5	20	20+15			
	6EA	355	20	15+15	25+12.5	-	266	20	15+12.5	20+15	-	177	15	25	20+12.5	-	89	12.5	15	25	25+12.5			
	5EA	458	-	-	-	-	344	20	15+15	25+12.5	-	229	15	25	20+15	-	115	12.5	20	15+15	20+25			
65x65	10EA	232	15	25	20+15	-	174	12.5	25	20+12.5	20+25	116	12.5	20	15+15	20+25	58	12.5	12.5	20	20+12.5			
	8EA	279	20	15+15	20+15	-	209	15	25	20+15	-	139	12.5	20	15+15	20+25	70	12.5	12.5	20	20+15			
	6EA	357	20	15+15	25+12.5	-	267	20	15+12.5	20+15	-	178	15	25	20+12.5	-	89	12.5	15	25	25+12.5			
	5EA	459	-	-	-	-	344	20	15+15	25+12.5	-	229	15	25	20+15	-	115	12.5	20	15+15	20+25			

*For other critical temperatures, encasement types, and non-standard steel members, contract technical@tgroup.com.au.

UNEQUAL ANGLES - COLUMNS

(550 Degrees Critical Temperature)



THICKNESS OF TRAFALGAR COREX

STEEL SIZE		4 SIDED ENCASUREMENT					3 SIDED ENCASUREMENT					2 SIDED ENCASUREMENT					1 SIDED ENCASUREMENT				
		Hp/A	FIRE RESISTANCE LEVELS				Hp/A	FIRE RESISTANCE LEVELS				Hp/A	FIRE RESISTANCE LEVELS				Hp/A	FIRE RESISTANCE LEVELS			
		1/m	60	90	120	180	1/m	60	90	120	180	1/m	60	90	120	180	1/m	60	90	120	180
150x100	12UA	179	15	25	20+12.5	-	143	12.5	20	20+12.5	20+25	89	12.5	15	25	25+12.5	36	12.5	12.5	12.5	20
	10UA	224	15	25	20+15	-	179	15	25	20+12.5	-	112	12.5	20	15+15	20+25	45	12.5	12.5	12.5	25
150x90	16UA	138	12.5	20	15+15	20+25	113	12.5	20	15+15	20+25	69	12.5	12.5	20	20+15	26	12.5	12.5	12.5	12.5
	12UA	179	15	25	20+12.5	-	145	12.5	25	20+12.5	20+25	89	12.5	15	25	25+12.5	34	12.5	12.5	12.5	20
	10UA	223	15	25	20+15	-	181	15	25	20+12.5	-	112	12.5	20	15+15	20+25	42	12.5	12.5	12.5	25
	8UA	270	20	15+12.5	20+15	-	220	15	25	20+15	-	135	12.5	20	15+15	20+25	51	12.5	12.5	15	15+15
125x75	12UA	182	15	25	20+12.5	-	148	12.5	25	20+12.5	20+25	91	12.5	15	25	20+20	34	12.5	12.5	12.5	20
	10UA	227	15	25	20+15	-	184	15	25	20+12.5	-	113	12.5	20	15+15	20+25	43	12.5	12.5	12.5	25
	8UA	273	20	15+12.5	20+15	-	222	15	25	20+15	-	136	12.5	20	15+15	20+25	51	12.5	12.5	15	15+15
	6UA	352	20	15+15	25+12.5	-	286	20	15+15	20+15	-	176	12.5	25	20+12.5	20+25	66	12.5	12.5	20	20+15
100x75	10UA	227	15	25	20+15	-	179	15	25	20+12.5	-	114	12.5	20	15+15	20+25	49	12.5	12.5	12.5	15+15
	8UA	274	20	15+12.5	20+15	-	215	15	25	20+15	-	137	12.5	20	15+15	20+25	59	12.5	12.5	20	20+12.5
	6UA	353	20	15+15	25+12.5	-	277	20	15+15	20+15	-	177	15	25	20+12.5	-	76	12.5	12.5	20	20+15
75x50	8UA	278	20	15+15	20+15	-	223	15	25	20+15	-	139	12.5	20	15+15	20+25	56	12.5	12.5	15	20+12.5
	6UA	356	20	15+15	25+12.5	-	281	20	15+15	20+15	-	178	15	25	20+12.5	-	71	12.5	12.5	20	20+15
	5UA	457	-	-	-	-	366	20	15+15	25+12.5	-	229	15	25	20+15	-	91	12.5	15	25	20+20
65x50	8UA	281	20	15+15	20+15	-	220	15	25	20+15	-	140	12.5	20	15+15	20+25	61	12.5	12.5	20	20+12.5
	6UA	359	20	15+15	25+12.5	-	281	20	15+15	20+15	-	179	15	25	20+12.5	-	78	12.5	12.5	25	25+12.5
	5UA	461	-	-	-	-	360	20	15+15	25+12.5	-	230	15	25	20+15	-	100	12.5	20	25	20+20

*For other critical temperatures, encasement types, and non-standard steel members, contract technical@tgroup.com.au.

SQUARE HOLLOW SECTIONS - COLUMNS

(550 Degrees Critical Temperature)



THICKNESS OF TRAFALGAR COREX

STEEL SIZE	4 SIDED ENCASUREMENT						3 SIDED ENCASUREMENT					2 SIDED ENCASUREMENT					1 SIDED ENCASUREMENT							
	Hp/A	FIRE RESISTANCE LEVELS					Hp/A	FIRE RESISTANCE LEVELS					Hp/A	FIRE RESISTANCE LEVELS					Hp/A	FIRE RESISTANCE LEVELS				
	1/m	60	90	120	180	1/m	60	90	120	180	1/m	60	90	120	180	1/m	60	90	120	180				
250x250	9	120	12.5	20	15+15	20+25	90	12.5	15	25	25+12.5	60	12.5	12.5	20	20+12.5	30	12.5	12.5	12.5	15			
	6	175	12.5	25	20+12.5	20+25	130	12.5	20	15+15	20+25	90	12.5	15	25	25+12.5	45	12.5	12.5	12.5	25			
200x200	9	125	12.5	20	15+15	20+25	90	12.5	15	25	25+12.5	60	12.5	12.5	20	20+12.5	30	12.5	12.5	12.5	15			
	6	180	15	25	20+12.5	-	135	12.5	20	15+15	20+25	90	12.5	15	25	25+12.5	45	12.5	12.5	12.5	25			
	5	210	15	25	20+15	-	160	12.5	25	20+12.5	20+25	105	12.5	20	25	20+20	55	12.5	12.5	15	15+15			
150x150	9	125	12.5	20	15+15	20+25	95	12.5	20	25	20+20	65	12.5	12.5	20	20+15	35	12.5	12.5	12.5	20			
	6	185	15	25	20+12.5	-	135	12.5	20	15+15	20+25	90	12.5	15	25	25+12.5	45	12.5	12.5	12.5	25			
	5	215	15	25	20+15	-	160	12.5	25	20+12.5	20+25	110	12.5	20	15+15	20+20	55	12.5	12.5	15	15+15			
125x125	9	130	12.5	20	15+15	20+25	100	12.5	20	25	20+20	65	12.5	12.5	20	20+15	35	12.5	12.5	12.5	20			
	6	185	15	25	20+12.5	-	140	12.5	20	15+15	20+25	95	12.5	20	25	20+20	45	12.5	12.5	12.5	25			
	5	220	15	25	20+15	-	165	12.5	25	20+12.5	20+25	110	12.5	20	15+15	20+20	55	12.5	12.5	15	15+15			
	4	265	20	15+12.5	20+15	-	200	15	25	20+15	-	135	12.5	20	15+15	20+25	70	12.5	12.5	20	20+15			
100x100	9	135	12.5	20	15+15	20+25	100	12.5	20	25	20+20	70	12.5	12.5	20	20+15	35	12.5	12.5	12.5	20			
	6	190	15	25	20+12.5	-	140	12.5	20	15+15	20+25	95	12.5	20	25	20+20	50	12.5	12.5	12.5	15+15			
	5	225	15	25	20+15	-	165	12.5	25	20+12.5	20+25	110	12.5	20	15+15	20+20	55	12.5	12.5	15	15+15			
	4	270	20	15+12.5	20+15	-	205	15	25	20+15	-	135	12.5	20	15+15	20+25	70	12.5	12.5	20	20+15			
	3	355	20	15+15	25+12.5	-	265	20	15+12.5	20+15	-	175	12.5	25	20+12.5	20+25	90	12.5	15	25	25+12.5			
89x89	6	190	15	25	20+12.5	-	145	12.5	25	20+12.5	20+25	95	12.5	20	25	20+20	50	12.5	12.5	12.5	15+15			
	5	225	15	25	20+15	-	170	12.5	25	20+12.5	20+25	115	12.5	20	15+15	20+25	60	12.5	12.5	20	20+12.5			
	3.5	310	20	15+15	25+12.5	-	235	15	25	20+15	-	155	12.5	25	20+12.5	20+25	80	12.5	15	25	25+12.5			
75x75	6	200	15	25	20+15	-	150	12.5	25	20+12.5	20+25	100	12.5	20	25	20+20	50	12.5	12.5	12.5	15+15			
	5	230	15	25	20+15	-	175	12.5	25	20+12.5	20+25	115	12.5	20	15+15	20+25	60	12.5	12.5	20	20+12.5			
	4	280	20	15+15	20+15	-	210	15	25	20+15	-	140	12.5	20	15+15	20+25	70	12.5	12.5	20	20+15			
	3.5	315	20	15+15	25+12.5	-	240	15	25	20+15	-	160	12.5	25	20+12.5	20+25	80	12.5	15	25	25+12.5			
	3	360	20	15+15	25+12.5	-	270	20	15+12.5	20+15	-	180	15	25	20+12.5	-	90	12.5	15	25	25+12.5			
65x65	6	205	15	25	20+15	-	150	12.5	25	20+12.5	20+25	100	12.5	20	25	20+20	50	12.5	12.5	12.5	15+15			
	5	235	15	25	20+15	-	175	12.5	25	20+12.5	20+25	120	12.5	20	15+15	20+25	60	12.5	12.5	20	20+12.5			
	4	285	20	15+15	20+15	-	215	15	25	20+15	-	145	12.5	25	20+12.5	20+25	75	12.5	12.5	20	20+15			
	3	365	20	15+15	25+12.5	-	270	20	15+12.5	20+15	-	180	15	25	20+12.5	-	90	12.5	15	25	25+12.5			
50x50	5	250	15	25	20+15	-	185	15	25	20+12.5	-	125	12.5	20	15+15	20+25	65	12.5	12.5	20	20+15			
	4	295	20	15+15	20+15	-	220	15	25	20+15	-	150	12.5	25	20+12.5	20+25	75	12.5	12.5	20	20+15			
	3	370	20	15+15	25+12.5	-	280	20	15+15	20+15	-	185	15	25	20+12.5	-	95	12.5	20	25	20+20			

*For other critical temperatures, encasement types, and non-standard steel members, contract technical@tgroup.com.au.

RECTANGULAR HOLLOW SECTIONS - COLUMNS

(550 Degrees Critical Temperature)



THICKNESS OF TRAFALGAR COREX

STEEL SIZE	Hp/A	4 SIDED ENCASUREMENT					3 SIDED ENCASUREMENT					2 SIDED ENCASUREMENT					1 SIDED ENCASUREMENT				
		FIRE RESISTANCE LEVELS					FIRE RESISTANCE LEVELS					FIRE RESISTANCE LEVELS					FIRE RESISTANCE LEVELS				
		1/m	60	90	120	180	1/m	60	90	120	180	1/m	60	90	120	180	1/m	60	90	120	180
250x150	9	125	12.5	20	15+15	20+25	100	12.5	20	25	20+20	60	12.5	12.5	20	20+12.5	40	12.5	12.5	12.5	25
	6	180	15	25	20+12.5	-	145	12.5	25	20+12.5	20+25	90	12.5	15	25	25+12.5	55	12.5	12.5	15	15+15
	5	210	15	25	20+15	-	170	12.5	25	20+12.5	20+25	105	12.5	20	25	20+20	65	12.5	12.5	20	20+15
200x100	9	125	12.5	20	15+15	20+25	105	12.5	20	25	20+20	65	12.5	12.5	20	20+15	45	12.5	12.5	12.5	25
	6	185	15	25	20+12.5	-	155	12.5	25	20+12.5	20+25	90	12.5	15	25	25+12.5	60	12.5	12.5	20	20+12.5
	5	215	15	25	20+15	-	180	15	25	20+12.5	-	110	12.5	20	15+15	20+20	75	12.5	12.5	20	20+15
	4	265	20	15+12.5	20+15	-	220	15	25	20+15	-	135	12.5	20	15+15	20+25	90	12.5	15	25	25+12.5
150x100	6	185	15	25	20+12.5	-	150	12.5	25	20+12.5	20+25	95	12.5	20	25	20+20	55	12.5	12.5	15	15+15
	5	220	15	25	20+15	-	175	12.5	25	20+12.5	20+25	110	12.5	20	15+15	20+20	65	12.5	12.5	20	20+15
	4	270	20	15+12.5	20+15	-	215	15	25	20+15	-	135	12.5	20	15+15	20+25	80	12.5	15	25	25+12.5
150x50	5	225	15	25	20+15	-	195	15	25	20+15	-	110	12.5	20	15+15	20+20	85	12.5	15	25	25+12.5
	4	275	20	15+12.5	20+15	-	240	15	25	20+15	-	140	12.5	20	15+15	20+25	105	12.5	20	25	20+20
	3	355	20	15+15	25+12.5	-	307	20	15+15	20+15	-	175	12.5	25	20+12.5	20+25	135	12.5	20	15+15	20+25
125x75	5	220	15	25	20+15	-	180	15	25	20+12.5	-	110	12.5	20	15+15	20+20	70	12.5	12.5	20	20+15
	4	270	20	15+12.5	20+15	-	220	15	25	20+15	-	140	12.5	20	15+15	20+25	85	12.5	15	25	25+12.5
	3	355	20	15+15	25+12.5	-	285	20	15+15	20+15	-	175	12.5	25	20+12.5	20+25	110	12.5	20	15+15	20+20
100x50	6	200	15	25	20+15	-	165	12.5	25	20+12.5	20+25	100	12.5	20	25	20+20	65	12.5	12.5	20	20+15
	5	230	15	25	20+15	-	195	15	25	20+15	-	115	12.5	20	15+15	20+25	80	12.5	15	25	25+12.5
	4	280	20	15+15	20+15	-	235	15	25	20+15	-	140	12.5	20	15+15	20+25	95	12.5	20	25	20+20
	3.5	315	20	15+15	25+12.5	-	265	20	15+12.5	20+15	-	160	12.5	25	20+12.5	20+25	105	12.5	20	25	20+20
	3	360	20	15+15	25+12.5	-	300	20	15+15	20+15	-	180	15	25	20+12.5	-	120	12.5	20	15+15	20+25
75x50	6	205	15	25	20+15	-	165	12.5	25	20+12.5	20+25	105	12.5	20	25	20+20	60	12.5	12.5	20	20+12.5
	5	235	15	25	20+15	-	190	15	25	20+12.5	-	120	12.5	20	15+15	20+25	70	12.5	12.5	20	20+15
	4	285	20	15+15	20+15	-	230	15	25	20+15	-	145	12.5	25	20+12.5	20+25	85	12.5	15	25	25+12.5
	3	365	20	15+15	25+12.5	-	290	20	15+15	20+15	-	180	15	25	20+12.5	-	110	12.5	20	15+15	20+20

*For other critical temperatures, encasement types, and non-standard steel members, contract technical@tgroup.com.au.

CIRCULAR HOLLOW SECTION - COLUMNS

(550 Degrees Critical Temperature)

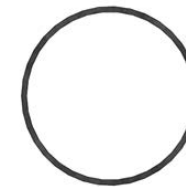

THICKNESS OF TRAFALGAR COREX

STEEL SIZE	4 SIDED ENCASEMENT				
	Hp/A 1/m	FIRE RESISTANCE LEVELS			
		60	90	120	180
300NB	111	12.5	20	15+15	20+25
250NB	116	12.5	20	15+15	20+25
200NB	139	12.5	20	15+15	20+25
150NB	147	12.5	25	20+12.5	20+25
125NB	166	12.5	25	20+12.5	20+25
100NB	190	15	25	20+12.5	-
90NB	233	15	25	20+15	-
80NB	301	20	15+15	20+15	-
65NB	336	20	15+15	25+12.5	-

*For other critical temperatures, encasement types, and non-standard steel members, contract technical@tgroup.com.au.

UNIVERSAL BEAMS

(620 Degrees Critical Temperature)

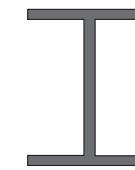

Click here to go back to Contents

THICKNESS - UNIVERSAL BEAMS

THICKNESS OF TRAFALGAR COREX

STEEL SIZE	4 SIDED ENCASEMENT						3 SIDED ENCASEMENT					2 SIDED ENCASEMENT					1 SIDED ENCASEMENT							
	Hp/A	FIRE RESISTANCE LEVELS					Hp/A	FIRE RESISTANCE LEVELS					Hp/A	FIRE RESISTANCE LEVELS					Hp/A	FIRE RESISTANCE LEVELS				
	1/m	60	90	120	180	1/m	60	90	120	180	1/m	60	90	120	180	1/m	60	90	120	180				
760UB	244	70	12.5	12.5	15	20+12.5	60	12.5	12.5	12.5	15+15	30	12.5	12.5	12.5	12.5	10	12.5	12.5	12.5	12.5			
	220	75	12.5	12.5	20	20+12.5	65	12.5	12.5	15	20+12.5	35	12.5	12.5	12.5	15	10	12.5	12.5	12.5	12.5			
	197	85	12.5	12.5	20	20+15	70	12.5	12.5	15	20+12.5	40	12.5	12.5	12.5	20	15	12.5	12.5	12.5	12.5			
	173	95	12.5	12.5	20	25+12.5	80	12.5	12.5	20	20+15	45	12.5	12.5	12.5	20	15	12.5	12.5	12.5	12.5			
	148	110	12.5	15	25	25+12.5	95	12.5	12.5	20	25+12.5	55	12.5	12.5	12.5	25	15	12.5	12.5	12.5	12.5			
690UB	140	105	12.5	15	25	25+12.5	90	12.5	12.5	20	20+15	50	12.5	12.5	12.5	25	15	12.5	12.5	12.5	12.5			
	125	115	12.5	15	25	20+20	100	12.5	15	25	25+12.5	60	12.5	12.5	12.5	15+15	20	12.5	12.5	12.5	12.5			
610UB	125	105	12.5	15	25	25+12.5	90	12.5	12.5	20	20+15	55	12.5	12.5	12.5	25	15	12.5	12.5	12.5	12.5			
	113	115	12.5	15	25	20+20	100	12.5	15	25	25+12.5	60	12.5	12.5	12.5	15+15	20	12.5	12.5	12.5	12.5			
	101	130	12.5	20	25	20+20	110	12.5	15	25	25+12.5	70	12.5	12.5	15	20+12.5	20	12.5	12.5	12.5	12.5			
530UB	92	125	12.5	20	25	20+20	110	12.5	15	25	25+12.5	65	12.5	12.5	15	20+12.5	20	12.5	12.5	12.5	12.5			
	82	140	12.5	20	15+15	20+25	120	12.5	15	25	20+20	70	12.5	12.5	15	20+12.5	20	12.5	12.5	12.5	12.5			
460UB	82	125	12.5	20	25	20+20	105	12.5	15	25	25+12.5	60	12.5	12.5	12.5	15+15	20	12.5	12.5	12.5	12.5			
	74	135	12.5	20	25	20+20	115	12.5	15	25	20+20	70	12.5	12.5	15	20+12.5	20	12.5	12.5	12.5	12.5			
	67	150	12.5	20	15+15	20+25	130	12.5	20	25	20+20	75	12.5	12.5	20	20+12.5	25	12.5	12.5	12.5	12.5			
410UB	60	155	12.5	20	15+15	20+25	130	12.5	20	25	20+20	75	12.5	12.5	20	20+12.5	25	12.5	12.5	12.5	12.5			
	54	170	12.5	20	15+15	20+25	145	12.5	20	15+15	20+25	85	12.5	12.5	20	20+15	30	12.5	12.5	12.5	12.5			
360UB	57	145	12.5	20	15+15	20+25	125	12.5	20	25	20+20	75	12.5	12.5	20	20+12.5	25	12.5	12.5	12.5	12.5			
	51	165	12.5	20	15+15	20+25	135	12.5	20	25	20+20	80	12.5	12.5	20	20+15	30	12.5	12.5	12.5	12.5			
	45	185	12.5	20	15+15	20+25	155	12.5	20	15+15	20+25	90	12.5	12.5	20	20+15	30	12.5	12.5	12.5	12.5			
310UB	46	160	12.5	20	15+15	20+25	130	12.5	20	25	20+20	80	12.5	12.5	20	20+15	30	12.5	12.5	12.5	12.5			
	40	180	12.5	20	15+15	20+25	150	12.5	20	15+15	20+25	90	12.5	12.5	20	20+15	35	12.5	12.5	12.5	15			
250UB	37	170	12.5	20	15+15	20+25	140	12.5	20	15+15	20+25	85	12.5	12.5	20	20+15	35	12.5	12.5	12.5	15			
	31	200	12.5	25	20+12.5	20+25	160	12.5	20	15+15	20+25	100	12.5	15	25	25+12.5	40	12.5	12.5	12.5	20			
200UB	30	180	12.5	20	15+15	20+25	145	12.5	20	15+15	20+25	90	12.5	12.5	20	20+15	40	12.5	12.5	12.5	20			
	25	210	12.5	25	20+12.5	20+25	165	12.5	20	15+15	20+25	105	12.5	15	25	25+12.5	45	12.5	12.5	12.5	20			
180UB	22	195	12.5	20	20+12.5	20+25	160	12.5	20	15+15	20+25	100	12.5	15	25	25+12.5	35	12.5	12.5	12.5	15			
	18	230	12.5	25	20+12.5	20+25	190	12.5	20	15+15	20+25	115	12.5	15	25	20+20	40	12.5	12.5	12.5	20			
150UB	18	200	12.5	25	20+12.5	20+25	170	12.5	20	15+15	20+25	100	12.5	15	25	25+12.5	35	12.5	12.5	12.5	15			
	14	250	12.5	25	20+12.5	20+25	210	12.5	25	20+12.5	20+25	125	12.5	20	25	20+20	40	12.5	12.5	12.5	20			

*For other critical temperatures, encasement types, and non-standard steel members, contract technical@tgroup.com.au.

WELDED BEAMS (620 Degrees Critical Temperature)



THICKNESS OF TRAFALGAR COREX

STEEL SIZE	4 SIDED ENCASEMENT						3 SIDED ENCASEMENT					2 SIDED ENCASEMENT					1 SIDED ENCASEMENT							
	Hp/A	FIRE RESISTANCE LEVELS					Hp/A	FIRE RESISTANCE LEVELS					Hp/A	FIRE RESISTANCE LEVELS					Hp/A	FIRE RESISTANCE LEVELS				
	1/m	60	90	120	180	1/m	60	90	120	180	1/m	60	90	120	180	1/m	60	90	120	180				
1200WB	455	60	12.5	12.5	12.5	15+15	50	12.5	12.5	12.5	25	30	12.5	12.5	12.5	12.5	10	12.5	12.5	12.5	12.5			
	423	65	12.5	12.5	15	20+12.5	55	12.5	12.5	12.5	25	35	12.5	12.5	12.5	15	10	12.5	12.5	12.5	12.5			
	392	70	12.5	12.5	15	20+12.5	60	12.5	12.5	12.5	15+15	35	12.5	12.5	12.5	15	10	12.5	12.5	12.5	12.5			
	342	75	12.5	12.5	20	20+12.5	65	12.5	12.5	15	20+12.5	40	12.5	12.5	12.5	20	10	12.5	12.5	12.5	12.5			
	317	80	12.5	12.5	20	20+15	70	12.5	12.5	15	20+12.5	40	12.5	12.5	12.5	20	10	12.5	12.5	12.5	12.5			
	278	90	12.5	12.5	20	20+15	80	12.5	12.5	20	20+15	45	12.5	12.5	12.5	20	10	12.5	12.5	12.5	12.5			
	249	95	12.5	12.5	20	25+12.5	85	12.5	12.5	20	20+15	50	12.5	12.5	12.5	25	10	12.5	12.5	12.5	12.5			
1000WB	322	70	12.5	12.5	15	20+12.5	60	12.5	12.5	12.5	15+15	35	12.5	12.5	12.5	15	10	12.5	12.5	12.5	12.5			
	296	75	12.5	12.5	20	20+12.5	65	12.5	12.5	15	20+12.5	40	12.5	12.5	12.5	20	15	12.5	12.5	12.5	12.5			
	258	85	12.5	12.5	20	20+15	75	12.5	12.5	20	20+12.5	45	12.5	12.5	12.5	20	15	12.5	12.5	12.5	12.5			
	215	95	12.5	12.5	20	25+12.5	85	12.5	12.5	20	20+15	50	12.5	12.5	12.5	25	15	12.5	12.5	12.5	12.5			
900WB	282	75	12.5	12.5	20	20+12.5	65	12.5	12.5	15	20+12.5	40	12.5	12.5	12.5	20	15	12.5	12.5	12.5	12.5			
	257	85	12.5	12.5	20	20+15	70	12.5	12.5	15	20+12.5	40	12.5	12.5	12.5	20	15	12.5	12.5	12.5	12.5			
	218	95	12.5	12.5	20	25+12.5	80	12.5	12.5	20	20+15	45	12.5	12.5	12.5	20	15	12.5	12.5	12.5	12.5			
	175	110	12.5	15	25	25+12.5	95	12.5	12.5	20	25+12.5	55	12.5	12.5	12.5	25	15	12.5	12.5	12.5	12.5			
800WB	192	95	12.5	12.5	20	25+12.5	80	12.5	12.5	20	20+15	50	12.5	12.5	12.5	25	15	12.5	12.5	12.5	12.5			
	168	105	12.5	15	25	25+12.5	90	12.5	12.5	20	20+15	55	12.5	12.5	12.5	25	15	12.5	12.5	12.5	12.5			
	146	120	12.5	15	25	20+20	100	12.5	15	25	25+12.5	60	12.5	12.5	12.5	15+15	15	12.5	12.5	12.5	12.5			
	122	135	12.5	20	25	20+20	115	12.5	15	25	20+20	65	12.5	12.5	15	20+12.5	20	12.5	12.5	12.5	12.5			
700WB	173	100	12.5	15	25	25+12.5	80	12.5	12.5	20	20+15	45	12.5	12.5	12.5	20	15	12.5	12.5	12.5	12.5			
	150	105	12.5	15	25	25+12.5	90	12.5	12.5	20	20+15	50	12.5	12.5	12.5	25	15	12.5	12.5	12.5	12.5			
	130	115	12.5	15	25	20+20	100	12.5	15	25	25+12.5	60	12.5	12.5	12.5	15+15	15	12.5	12.5	12.5	12.5			
	115	130	12.5	20	25	20+20	115	12.5	15	25	20+20	65	12.5	12.5	15	20+12.5	20	12.5	12.5	12.5	12.5			

*For other critical temperatures, encasement types, and non-standard steel members, contract technical@tgroup.com.au.

PARALLEL FLANGE BEAMS

(620 Degrees Critical Temperature)



THICKNESS OF TRAFALGAR COREX

STEEL SIZE	4 SIDED ENCASUREMENT					3 SIDED ENCASUREMENT					2 SIDED ENCASUREMENT					1 SIDED ENCASUREMENT				
	Hp/A	FIRE RESISTANCE LEVELS				Hp/A	FIRE RESISTANCE LEVELS				Hp/A	FIRE RESISTANCE LEVELS				Hp/A	FIRE RESISTANCE LEVELS			
	1/m	60	90	120	180	1/m	60	90	120	180	1/m	60	90	120	180	1/m	60	90	120	180
380PFC	140	12.5	20	15+15	20+25	125	12.5	20	25	20+20	70	12.5	12.5	15	20+12.5	15	12.5	12.5	12.5	12.5
300PFC	157	12.5	20	15+15	20+25	139	12.5	20	15+15	20+20	78	12.5	12.5	20	20+15	18	12.5	12.5	12.5	12.5
250PFC	154	12.5	20	15+15	20+25	134	12.5	20	25	20+20	77	12.5	12.5	20	20+15	20	12.5	12.5	12.5	12.5
230PFC	196	12.5	20	20+12.5	20+25	172	12.5	20	15+15	20+25	98	12.5	12.5	25	25+12.5	24	12.5	12.5	12.5	12.5
200PFC	193	12.5	20	15+15	20+25	167	12.5	20	15+15	20+25	97	12.5	12.5	25	25+12.5	26	12.5	12.5	12.5	12.5
180PFC	196	12.5	20	20+12.5	20+25	168	12.5	20	15+15	20+25	98	12.5	12.5	25	25+12.5	29	12.5	12.5	12.5	12.5
150PFC	205	12.5	25	20+12.5	20+25	171	12.5	20	15+15	20+25	102	12.5	15	25	25+12.5	34	12.5	12.5	12.5	12.5
125 PFC	257	15	25	20+12.5	-	213	12.5	25	20+12.5	20+25	129	12.5	20	25	20+20	44	12.5	12.5	12.5	20
100 PFC	290	15	25	20+12.5	-	242	12.5	25	20+12.5	20+25	145	12.5	20	15+15	20+25	48	12.5	12.5	12.5	25

*For other critical temperatures, encasement types, and non-standard steel members, contract technical@tgroup.com.au.

PRODUCT RANGE



Item Number	Thickness	Board Size	Pallet QTY	Weight per Board
COREX-12.5	12.5mm	2000mm x 1200mm	40	27.6kg
COREX-15	15mm	2000mm x 1200mm	32	32.4kg
COREX-20	20mm	2000mm x 1200mm	24	42.24kg
COREX-25	25mm	2000mm x 1200mm	18	52.6kg

PRODUCT RANGE ACCESSORIES

Item Number	Gauge	Size
COREX Staples 40	16g	40
COREX Staples 50	16g	50

SAFE CUTTING, WORKING/HANDLING AND STORAGE OF TRAFALGAR COREX

Trafalgar COREX can be easily cut with a wood saw or similar, ensure that gloves and eye protection are worn for safety while cutting. When cutting large quantities of Trafalgar COREX, use a dust mask or respirator as the cutting process will generate dust. If using power tools to cut, utilize dust extraction to reduce the dust created.

Installation is done with staples and a staple gun. When stapling use eye protection, as the board may crack if the staples are too close to the edge. While stapling, ensure to temporarily fix the board using another method to ensure you can keep your hands clear of the board while installing the staples.

Store Trafalgar COREX in a dry location, as water can damage the board. If the board is damaged or cracked in any way, dispose of the affected sheets to avoid the risk of a piece dislodging and falling during/after installation.

Watch the video installation on the Trafalgar TV YouTube channel for a guide.

Please refer to Trafalgar COREX MSDS at the end of this manual.



COMPLIANCE WITH THE NCC



Section 12 of AS4100 specifies the requirements for steel building elements that require a fire resistance level (FRL). This section states that protected steel members or connections must be protected to give a Period of structural adequacy (PSA) equal to the required FRL.

Section 12.8 specifies that the PSA of a system can be determined in accordance with AS1530.4 from a single test for an installation consisting of:

- Fire protection system is the same as the prototype
- Fire protection material is equal or greater than that of the prototype
- Surface area to mass ratio is less than or equal to that of the prototype
- The conditions of the support are the same as the prototype and the restraints are not less favourable
- The ratio of the design load for fire to the design capacity of the member is less than or equal to that of the prototype

Compliance will only be achieved when the installation on site mirrors the approved and fire tested systems.

Multiple full scale fire tests have yielded the FAS 200445 approval report for Trafalgar COREX, written by expert Fire Engineers from a NATA approved laboratory in accordance with AS1530.4-2014 and AS4100-1998, and provides evidence of compliance under the current NCC, and is ready for NCC 2022 requirements.

The aim of the assessment is to determine the required board thickness for various steel sections, based on more than 9 actual fire tests for Trafalgar COREX.

The assessment calculates using a regression formula given in AS4100 the relationship between the thickness of fire stopping, the temperature of the test, and the duration of the test. This regression is what gives the data for the Hp/A Tables.



An important part of the fire testing in this manual is the 'stickability' of the board under load and fire conditions. The system must have proven ability to adhere/attach to the structure steel in a robust way such that it will not fall off. Trafalgar COREX is an extremely robust system, and impact resistant, making it perfect for steel that is likely to be bumped in highly trafficked areas.

REGRESSION COEFFICIENTS

Regression Coefficient	Single Layer Protection	Two-layer Protection
k_0	-29.3473	-84.611
k_1	1.944724	3.116547
k_2	-3.1305	12.60062
k_3	0.059186	0.087416
k_4	0.001222	0.001442
k_5	0.027519	0.002894
k_6	0.711107	0.502558

AS4100 Regression coefficients, given as per FAS 200445 (Assessment report in accordance with AS1530.4).

FAQ

Q Do I require any steel angles for applying the Trafalgar COREX?

A No, Trafalgar COREX is simply stapled together.

Q How do I achieve a thickness of 40mm?

A Two layers of the 20mm board can be used.

Q What if my steel section is not in this manual?

A Contact technical@tgroup.com.au for free technical assistance.

Q Is sealant required for the system?

A No, it is a dry system.

Q Do I need to protect connecting steel members (secondary steel attachments)?

A We recommend a best practice of protecting secondary members to a length of 450mm away from the primary protected member, but this could be specified differently in the building design.

Q What if I interface with spray or intumescent paint system?

A Trafalgar Fire has an approved system where Trafalgar COREX must cover paint and spray by 100mm after the interface.

Q How do I protect steel baseplates for columns?

A If the steel baseplate is exposed and needs protecting, contact technical@tgroup.com for details

SOCIAL MEDIA



LinkedIn

YouTube

Trafalgar Fire reserves the right to change specifications without notice. Please check with your supplier at the time of order. The information contained in this Product Manual was correct at the time of publication. E&OE.

COREX 3 & 4 SIDED - OPEN WEB ENCASEMENT LAYOUT

Open Web Steel Sections

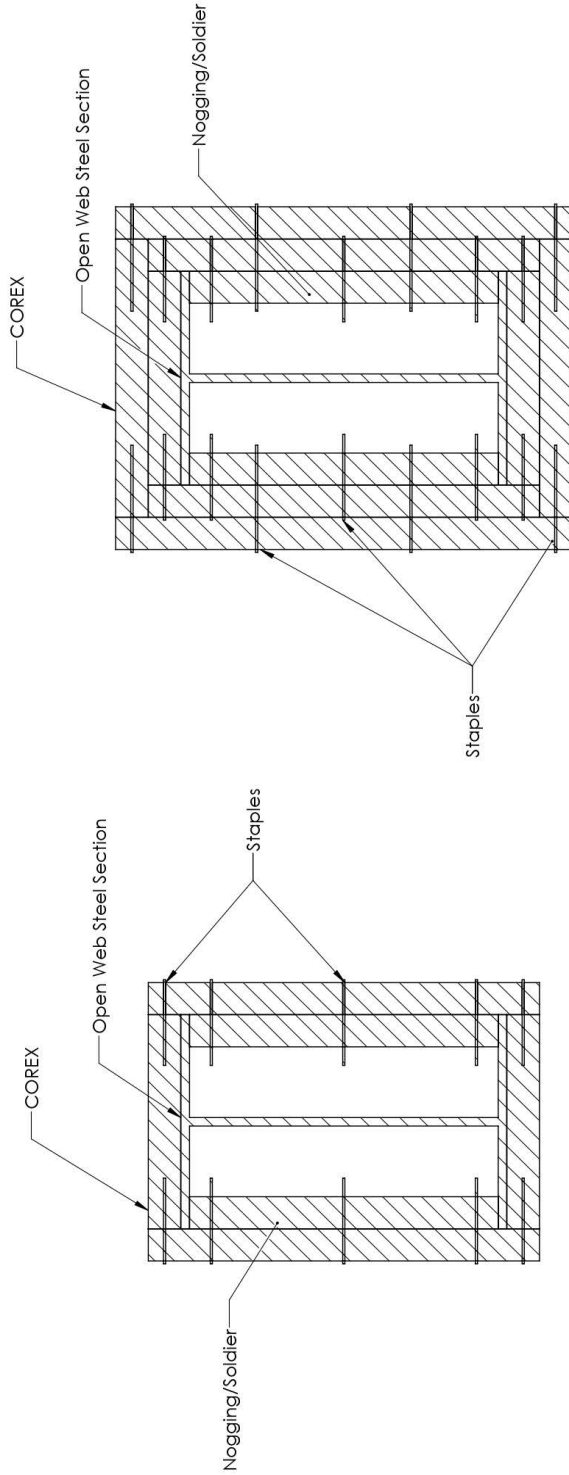

Drawing Name: Single and Double Layer		Test Standard: AS1530.4	Codes:	Revision:	Date:	No.:	NOTICE:
Project Title: Corex Drawing - Encasement layout		Fire resistance level:	Drawn By: SM				NOTE: ALL DIMENSIONS ARE IN MILLIMETRES (mm) Trafalgar Head Office: PO BOX 546 Cherry Hill NSW 2162 P: 1800 888 714 E: technical@group.com.au W: www.tfire.com.au
Drawing No.: 1	Sheet: 1 of 1	Date: 26/05/2023	Checked By: JH	<input type="checkbox"/> STANDARD DRAWING	<input type="checkbox"/> PROJECT DRAWING		
		Scale: NTS					

COREX 4-SIDED - CLOSED SECTION ENCASUREMENT LAYOUT

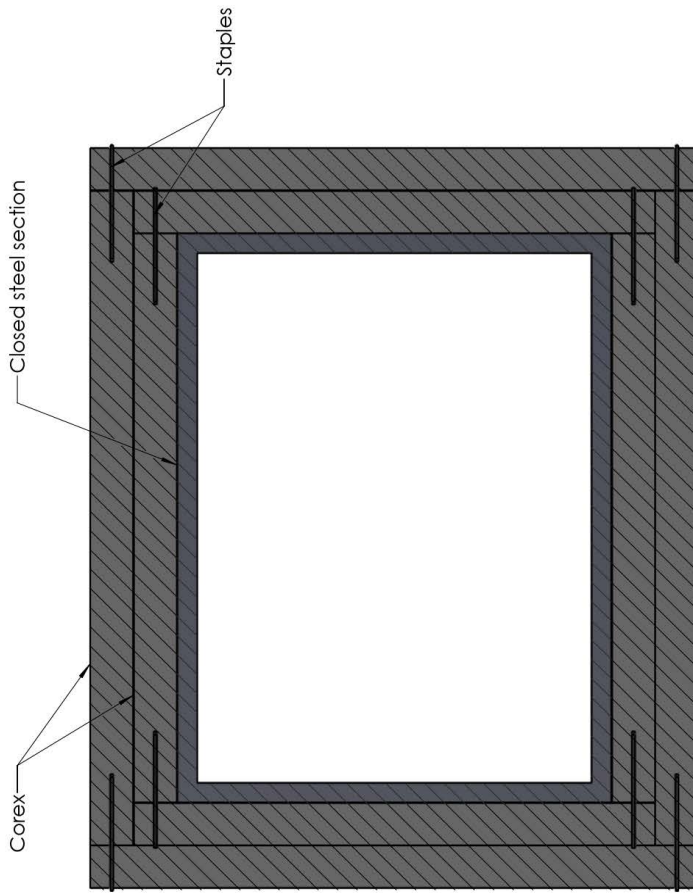
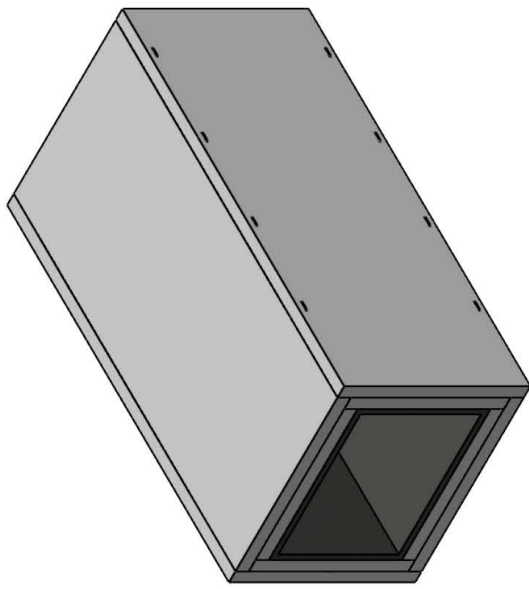

Double layer encasement

Drawing Name: Double layer encasement	Test Standard: AS1530.4	Codes:	Revision:	Date:	No.:	NOTICE:
Project Title: Corex with closed metal beam drawings	Fire resistance level:	Drawn By: MI				NOTE: ALL DIMENSIONS ARE IN MILLIMETRES (mm) Trafalgar Head Office: PO BOX 546 Cherry Hill NSW 2162 P: 1800 888 714 E: technical@group.com.au W: www.tfire.com.au
Drawing No.: 2	Sheet: 2 of 2	Checked By: JH	<input type="checkbox"/> STANDARD DRAWING			TRAFALGAR FIRE
Date: 5/26/2023	Scale: NTS		<input type="checkbox"/> PROJECT DRAWING			

COREX 3-SIDED - CLOSED SECTION ENCASEMENT LAYOUT

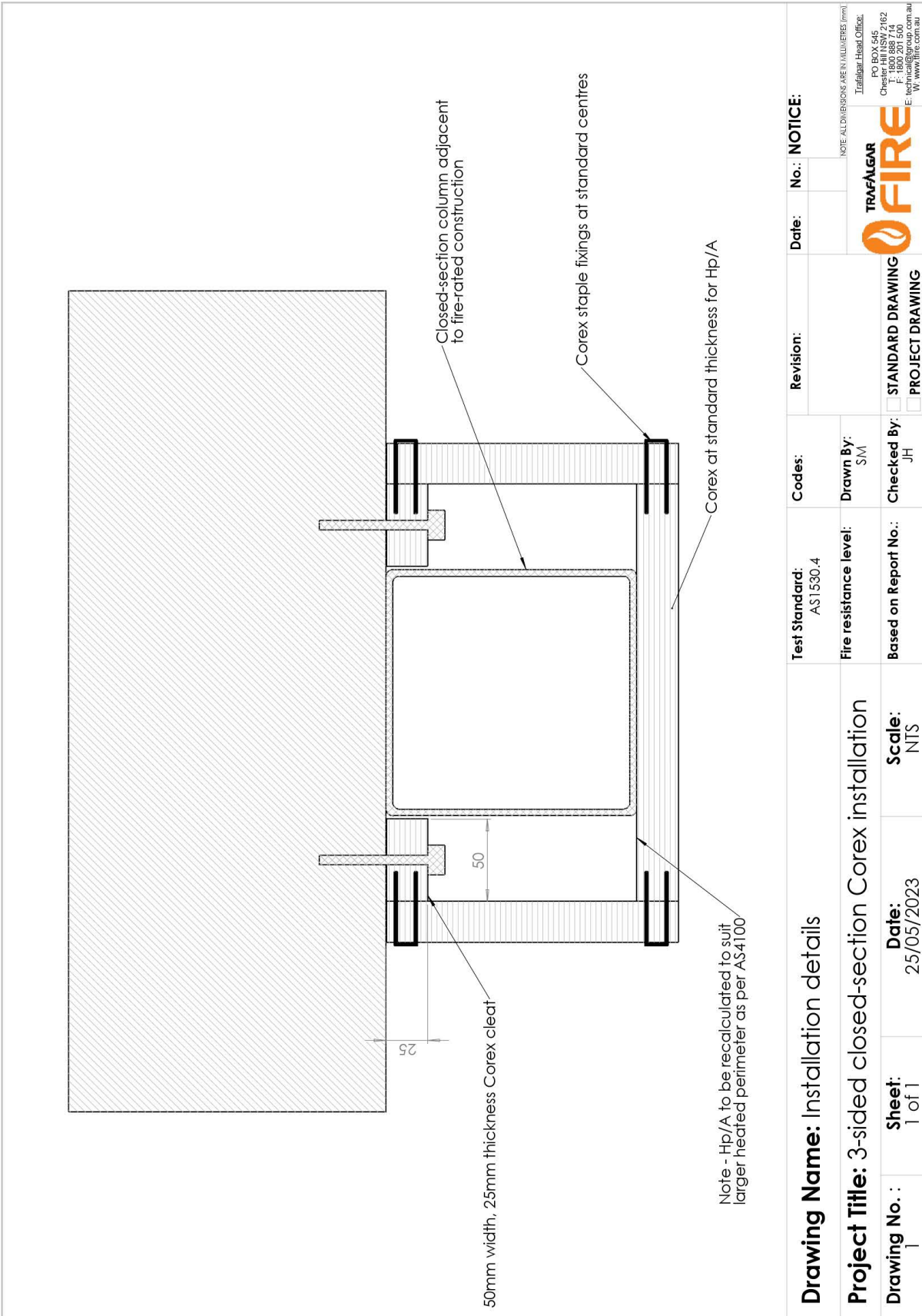

STEEL POST INSIDE BLOCKWALLS - PROTECTED WITH COREX BOARD

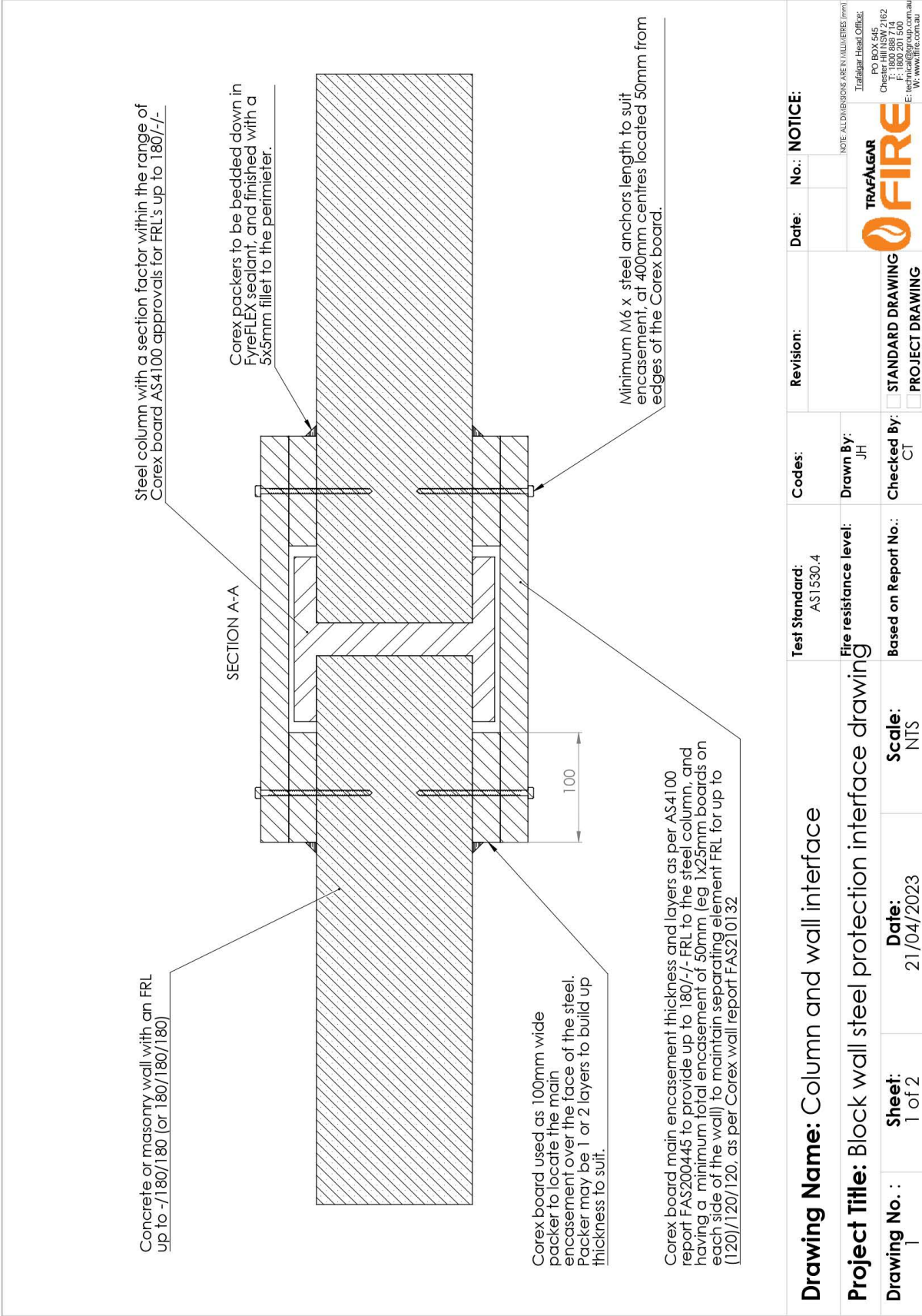

STEEL POST INSIDE BLOCKWALLS - PROTECTED WITH COREX BOARD

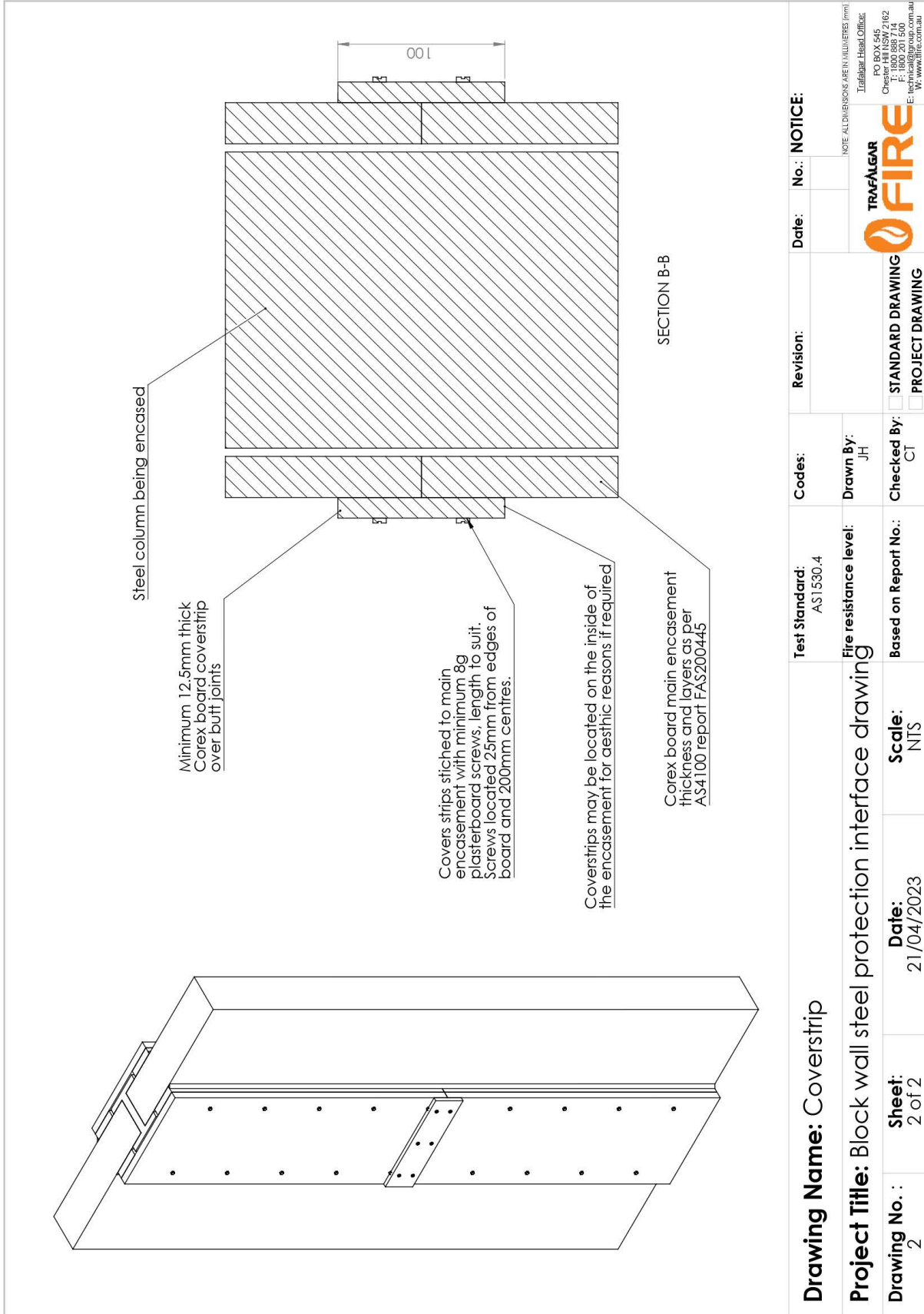

TRAFALGAR COREX AND INTUMESCENT

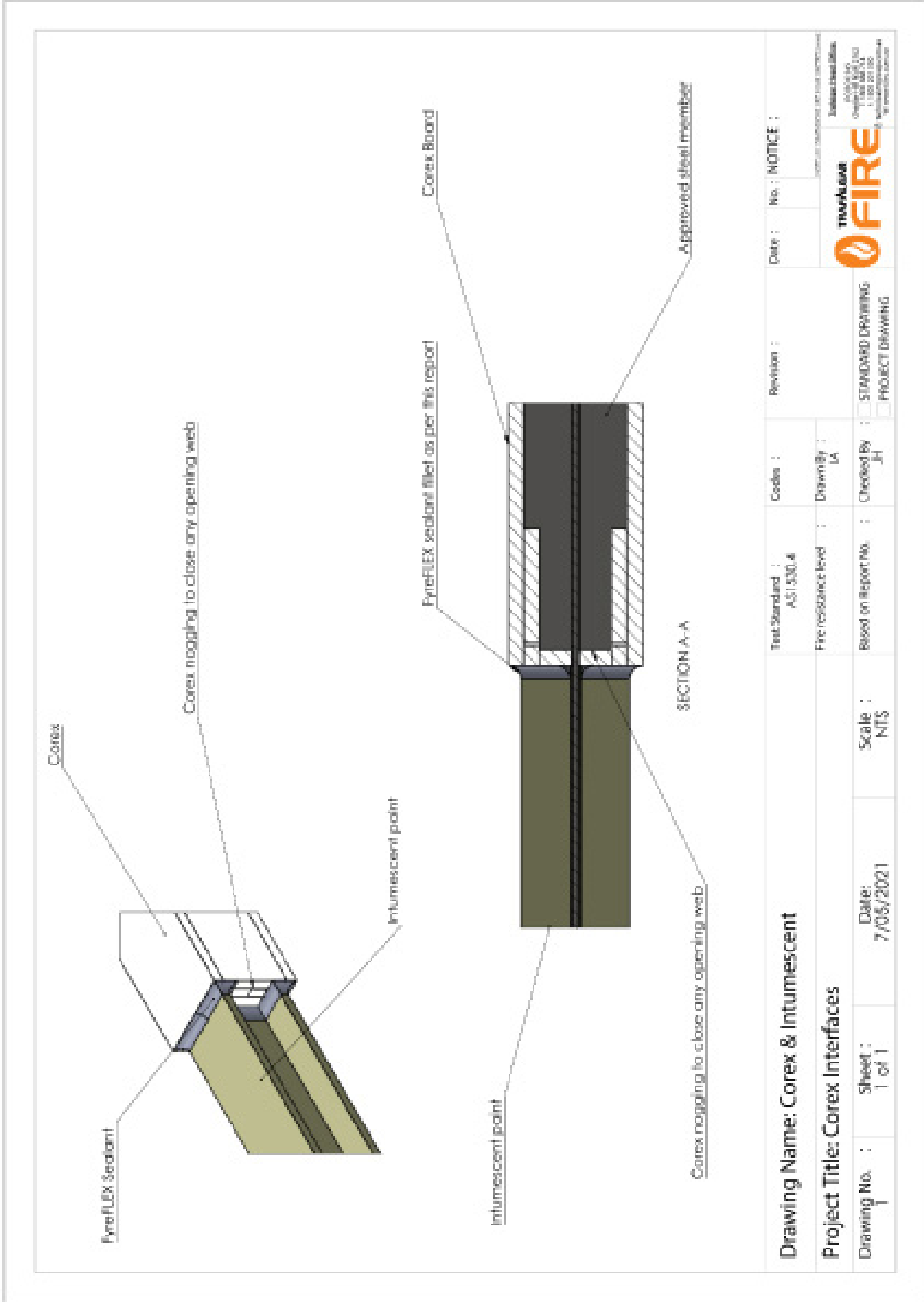

SHS - TRAFALGAR COREX & INTUMESCENT

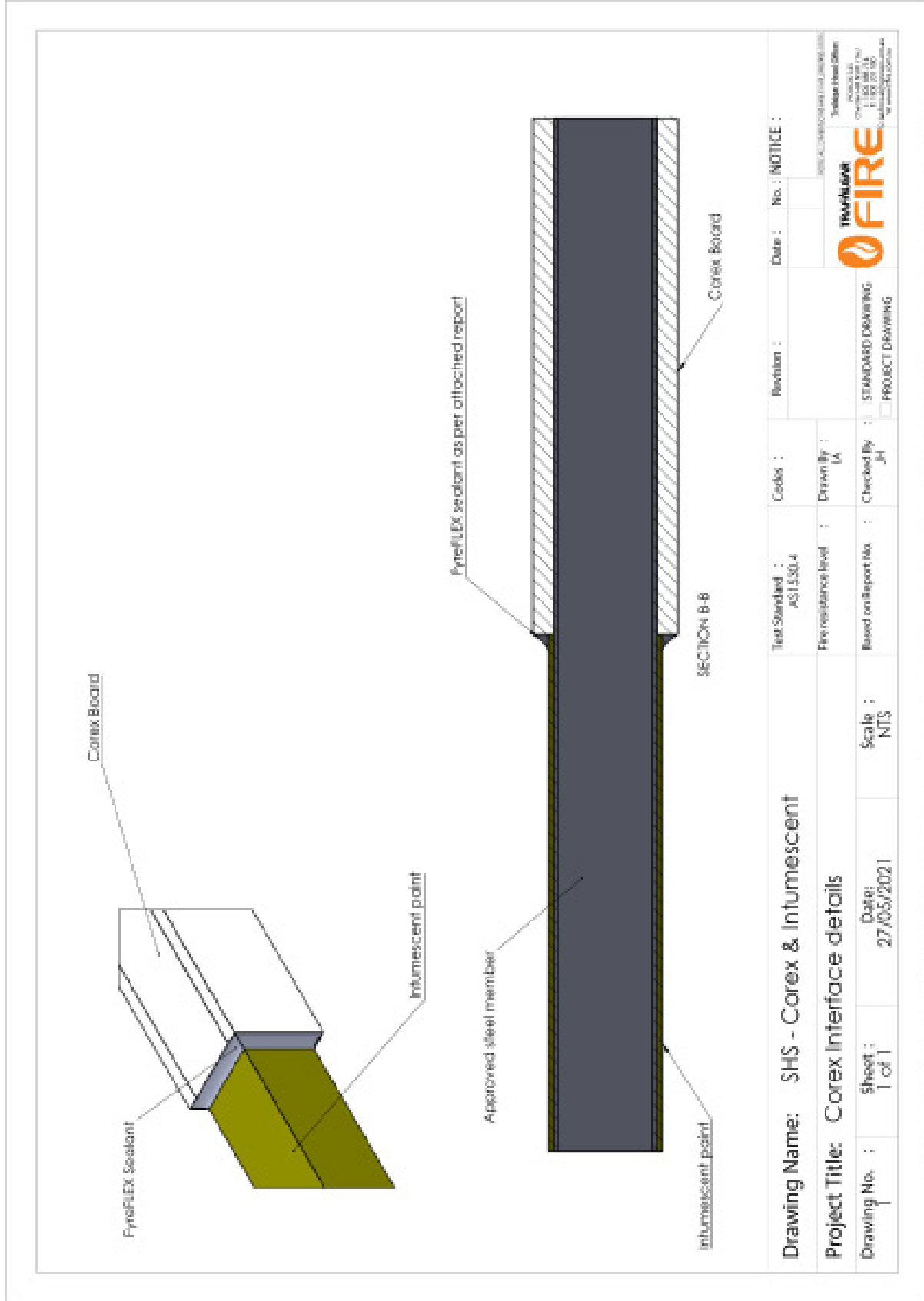

Drawing Name: SHS - Corex & Intumescent	Test Standard: AS1530.4	Codes:	Revision:	Date:	No.:	NOTICE:
Project Title: Corex Interface details	Fire resistance level:	Drawn by: LA				
Drawing No.: 1 of 1	Based on Report No.:	Checked by: JH				
Sheet: 1 of 1	Date: 27/05/2021	Scale: NTS	STANDARD DRAWING PROJECT DRAWING			

SHS - SPRAY OVER BOARD

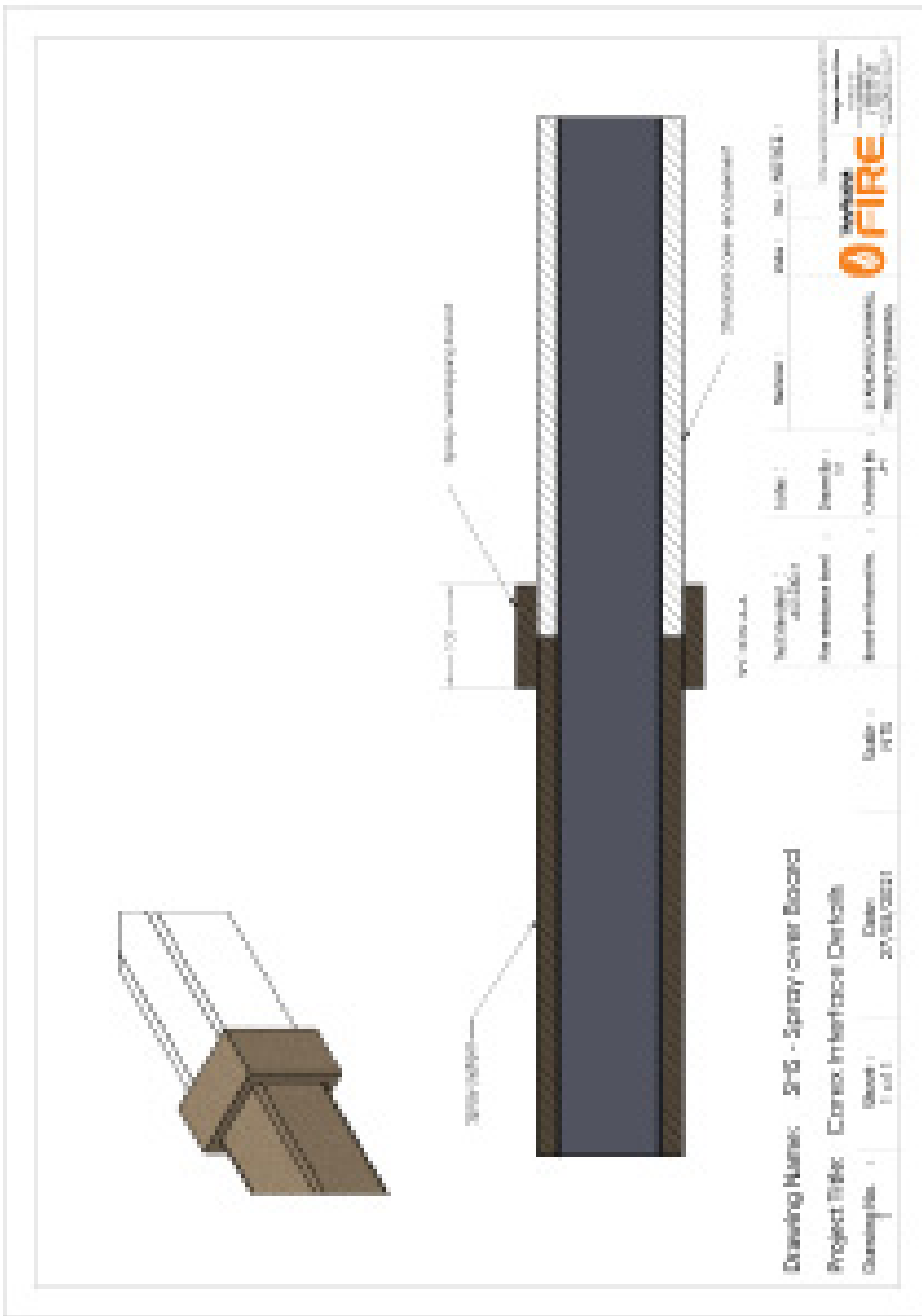

SHS - BOARD OVER SPRAY



BEAM PARALLEL TO VOID

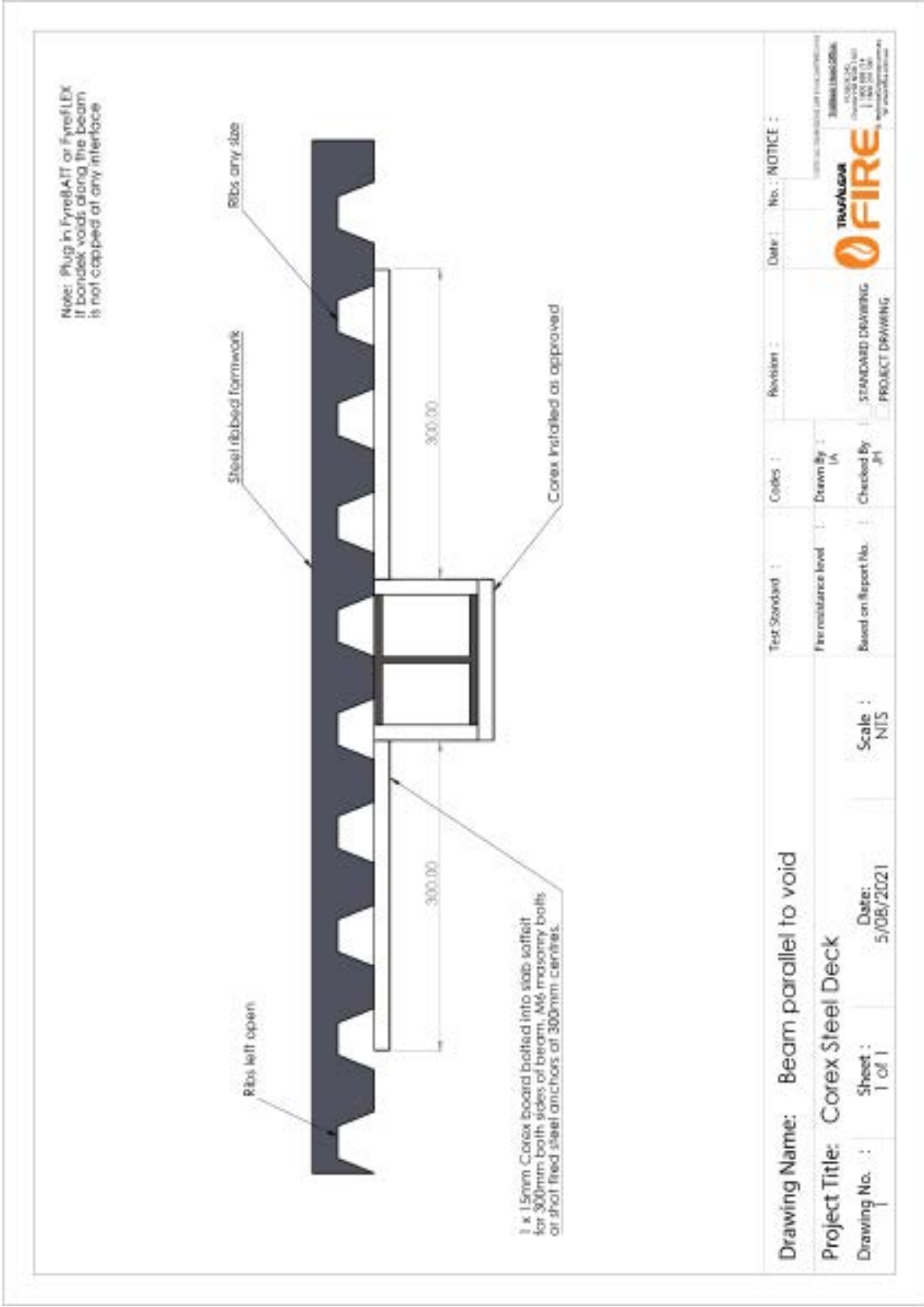

EXTENDED OVERLAP SECONDARY BEAM

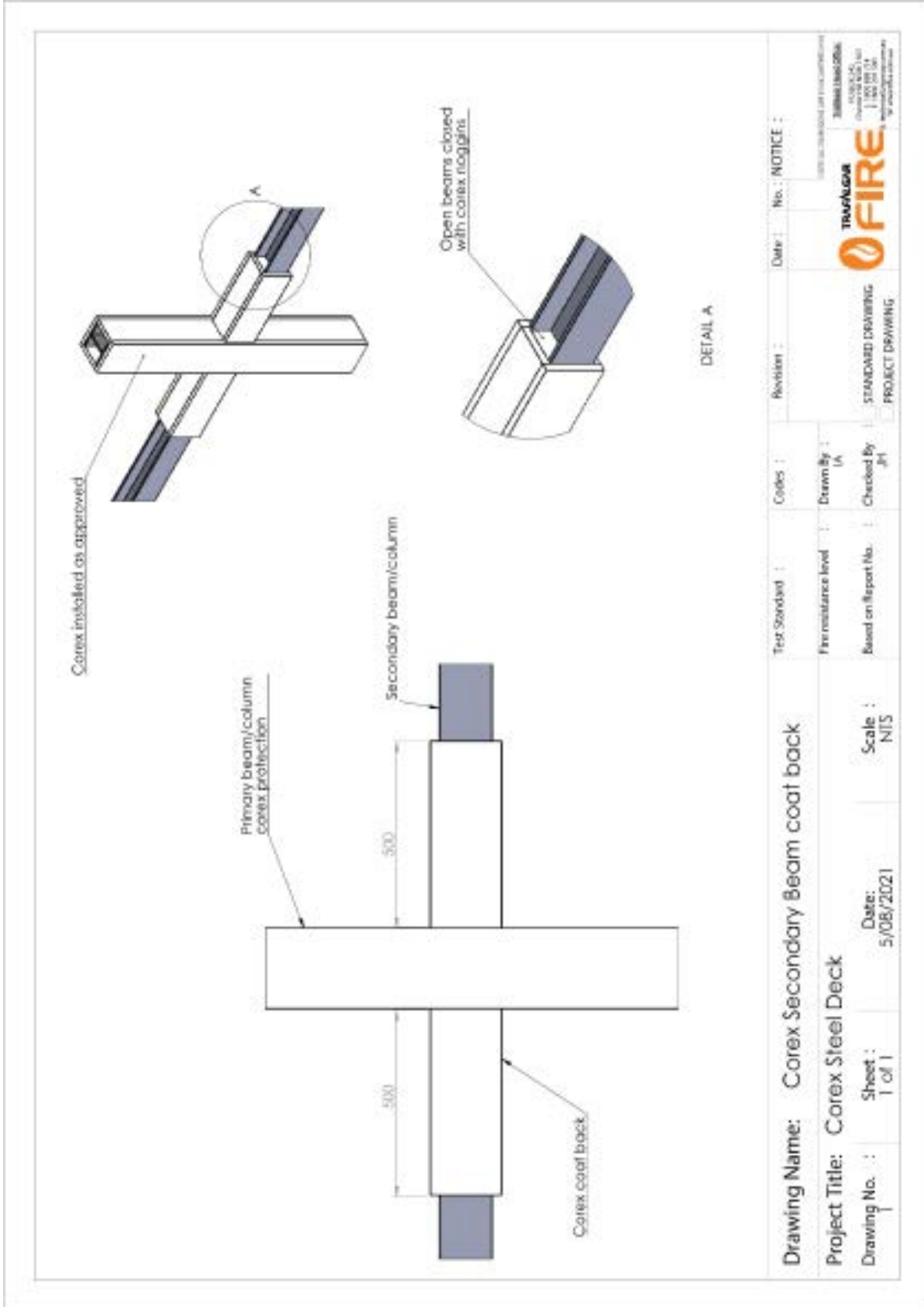

NON-TREATED VOID

Note: Plug in FireBATT or PyroFLEX if bonded voids along the beam & not capped at any interface

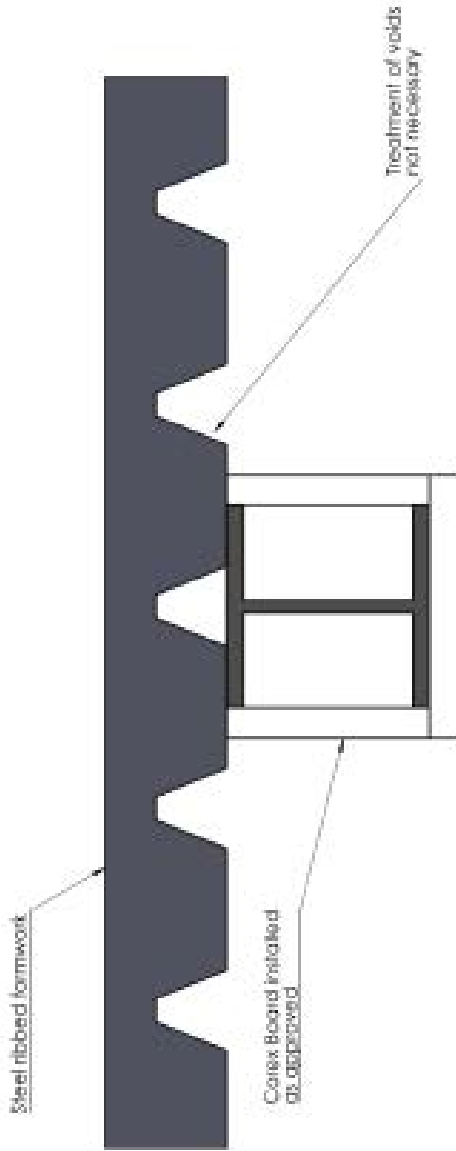

Drawing Name: Beam parallel to void		Codes:	Revision:	Date:	No.:	NOTICE:
Project Title: Corex Steel Deck		Drawn by: (A)	TRAFALGAR FIRE		<small>TRAFALGAR FIRE PROTECTION SYSTEMS PTY LTD 100/101 100/101 100/101 100/101 100/101 100/101</small>	
Drawing No.:	Sheet: 1 of 1	Date: 5/08/2021	Check By: (M)	STANDARD DRAWING PROJECT DRAWING		
Test Standard:		Permit to install level:	Based on Report No.:			
Scale: NTS						

BEAM EDGE OF SLAB

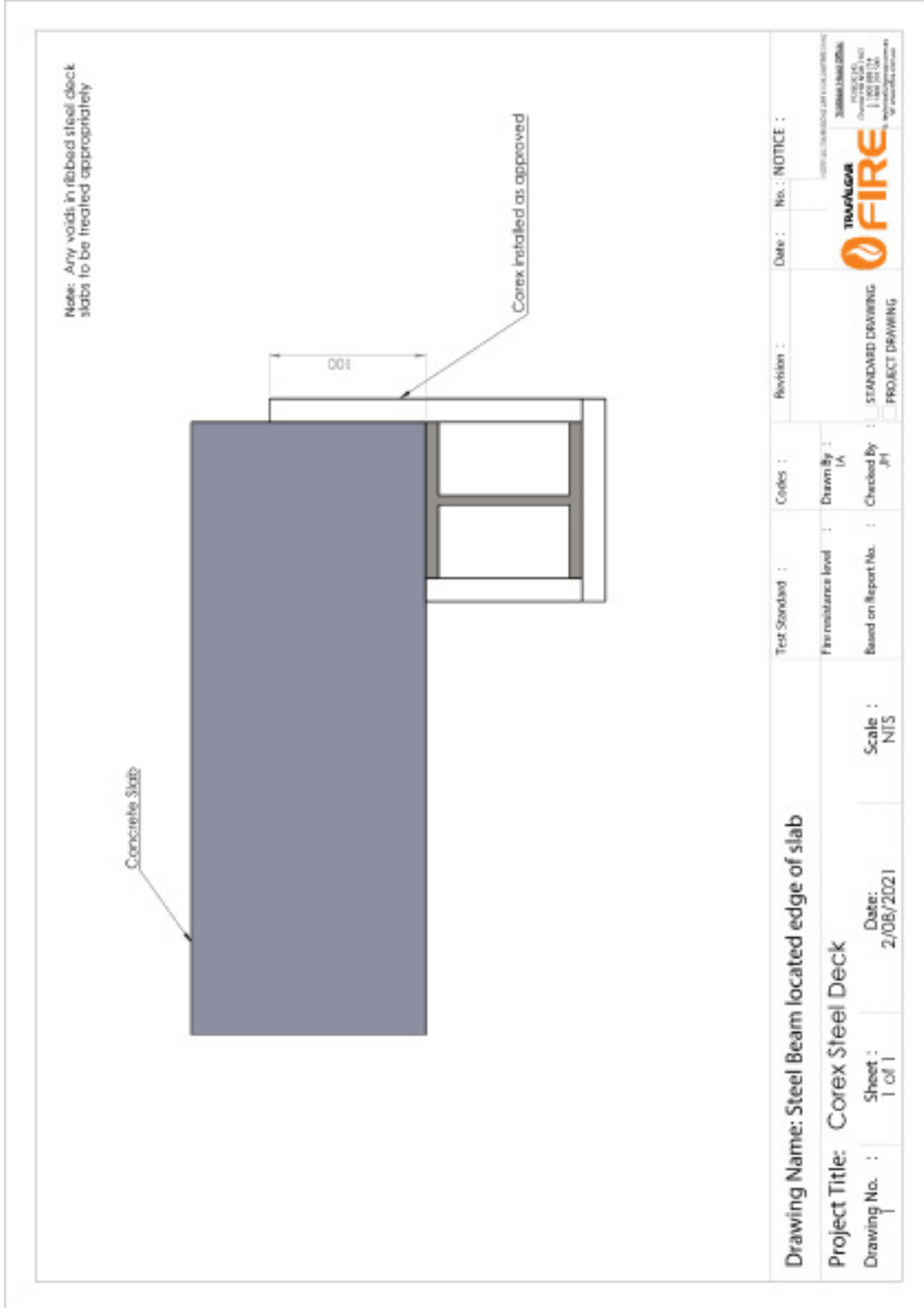

RIB VOIDS WITH FYREBATT



VOID FILLED WITH FYREFLEX

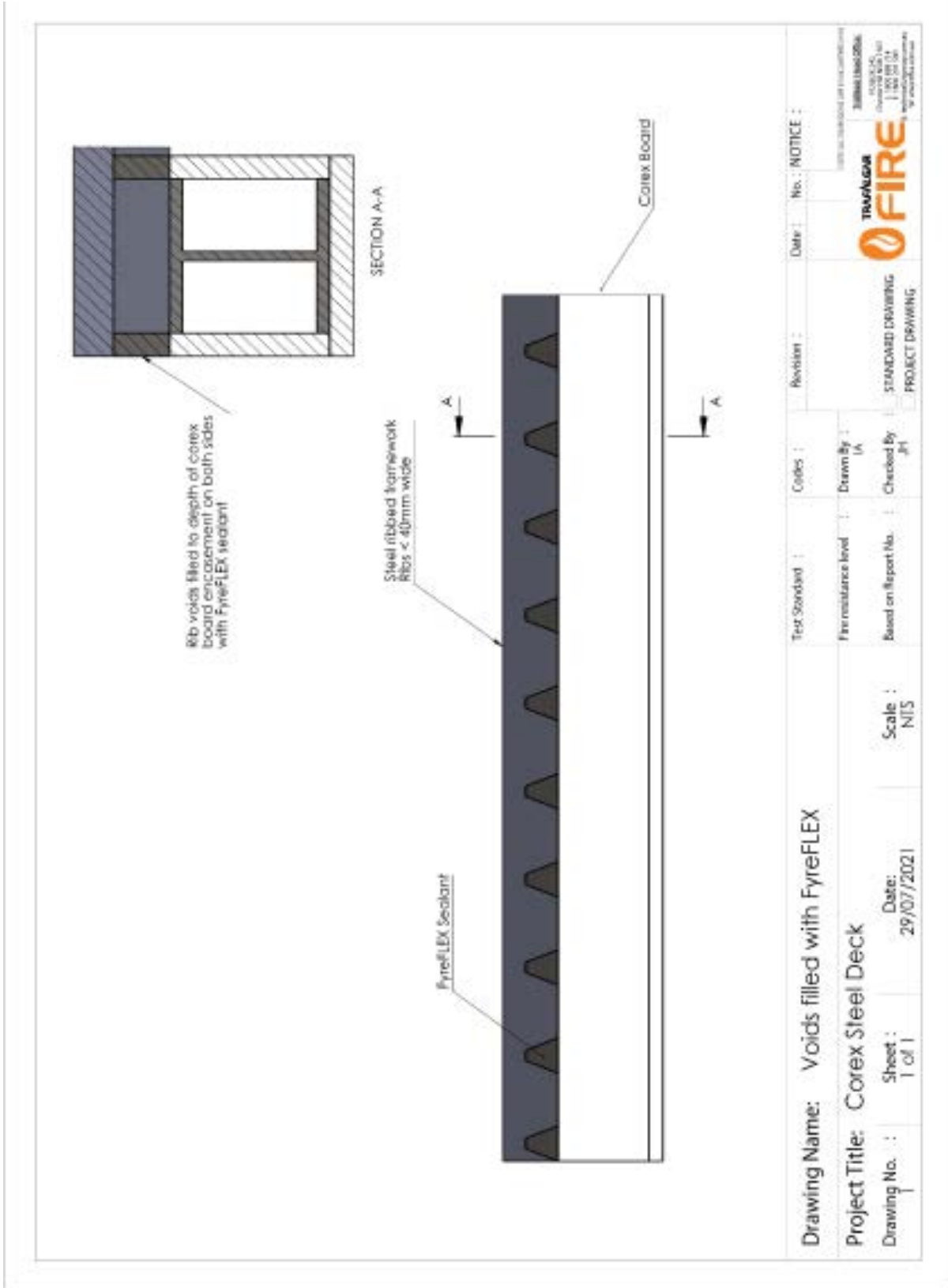

UL GREENGUARD GOLD



DALSAN ALICI SANAYI VE TICARET A.Ş.

A1 COREX

PRODUCT NO: A1-COREX

A1 COREX is a plasterboard used in the cladding of existing walls and partition walls, in the construction of suspended ceilings, shaft walls and ventilation ducts, and to enhance the fire resistance of steel and wooden structural components.

SSSS | 1 certification



- PRODUCT INFORMATION
- REVIEWS

CERTIFICATIONS AND STANDARDS

Greenguard

GENERAL

MasterFormat® Number:	09 20 00
Certifiers:	UL Environment
UL GREENGUARD:	Yes
UL GREENGUARD GOLD:	Yes
Third Party Ecolabels:	UL GREENGUARD, UL GREENGUARD Gold
Federal Standard - Single Attribute:	UL GREENGUARD GOLD
Category:	Construction Materials
Subcategory:	Wallboard/Gypsum Board/Drywall

ECOGUIDANCE



This product contains one or more of the following certifications or ecolabels: Cradle-to-cradle, Declare, EPD, HPD, Greenguard Gold, Transparency Reports, Energy Star, Greentag, NSI-347, Healthier Hospitals Compliant or SCS Indoor Advantage Gold.