

FyreBOX Slab-Mount



The FyreBOX Slab-Mount is a proudly Australian made passive fire penetration system used for multiple and mixed service penetrations which has been designed and tested to be built into residential/commercial apartment walls and riser shafts reducing the space required for service penetrations, providing predictable site costs and a reliable method of fire stopping.



BIM MODELS NOW AVAILABLE
CLICK HERE

Click to Watch Installation Video



KEY FEATURES

- Allows firestopping to be installed before the walls are constructed
- One penetration for multiple and mixed services to pass through in any quantity or configuration
- No minimum fill ratios required
- Space saving, eliminates the need for 200mm separation between adjacent services
- Tested for residential and commercial wall types
- Acoustic performance Rw50
- Thoroughly fire tested to AS1530.4-2014 at independent laboratories

APPLICATIONS

Electricians	<ul style="list-style-type: none"> • Power • Aluminium Core Cables • Data cables • Conduits
Plumbers	<ul style="list-style-type: none"> • PEX pipes • PEX-AL-PEX pipes • Metal pipes
HVAC&R	<ul style="list-style-type: none"> • Insulated pipes • Pair coils
Active Fire	<ul style="list-style-type: none"> • Sprinkler pipes • Fire cables

TRADES



TABLE OF CONTENTS



Section		Page
Benefits		4
FyreBOX - Major Benefits with Fire Protection 30% Labour Savings		5
System Selector		6
Fire Resistance Level		7
FRL Tables	60 Minute Plasterboard Stud Walls: WRAP FREE	8
	60 Minute Walsc® AAC Panel: WRAP FREE	9
	60 Minute Concrete, Masonry and Permanent Formwork Walls: WRAP FREE	10
	60 Minute IntrWall & Other Party Wall Systems	11
	60 Minute XCEM Alpha Panel walls	12
	90 Minute Walsc® AAC Panel	13
	90 Minute Plasterboard Stud Walls	14
	90 Minute Laminated Plasterboard Shaft Walls	15
	90 Minute XCEM Alpha Panel Walls	16
	120 Minute Plasterboard Stud Walls	17
	120 Minute Concrete, Masonry and Permanent Formwork Walls	18
	120 Minute Walsc® AAC Panels	19
	Speedpanel® Walls	20
	Trafalgar COREX Shaft Walls	21
Maxilite Board Bulkheads & Oversized Penetrations	22	
Installation Manual	Stage 1: Slab-Mount the FyreBOX- All Walls	23
	Stage 2: Wall Installation- Plasterboard and COREX	24
	Stage 2: Wall Installation- Walsc® and Hebel AAC Panel Wall	25
	Stage 2: Wall Installation- AlphaPanel	26
	Stage 2: Wall Installation- Speedpanel®	27
	Stage 3: Foam Installation- All Walls	28
	Stage 4: Wrapping- All Walls	29

TABLE OF CONTENTS



Section	Page	
Installation Manual	Installation Alternatives: Riser Shaft	30
	Installation Alternatives: Stepped slab, Wall junctions, oversized openings	31
	Installation Alternatives: FyreBOX Double Vertical	32
	Installation Alternatives: FyreBOX Double Horizontal	33
	Installation Alternatives: IntRWall/Party Walls	34
	Installation Checklist- Plasterboard	35
	Installation Checklist- Walsc® and Hebel AAC Panel Wall	36
System Range	37	
Compliance	38	
Technical Drawings	Installation Overview	39
	Plasterboard Framing Details	40
	Standard Plasterboard Walls	41
	Shaftliner Walls	42
	Hebel®/Walsc® and AAC Walls- Openings up to 400x170mm	43
	Hebel®/Walsc® and AAC Walls- Openings greater than 400x170mm	44
	SpeedPanel® Walls	45
	Concrete / Masonry Walls	46
	FyreBOARD™ Maxilite	47
	TWRAP™ - Services Wrap	48
	TWRAP™ - 3-Sided Wrap	49
	TWRAP™ - Stacked Vertical	50
	TWRAP™ - Services Horizontal	51
	Stepped Slab	52
	Wall Junctions	53
Oversized Openings	54	

WHY FyreBOX?

After various high profile fires that have occurred around the world and in Australia, passive fire defects in both high-rise residential and commercial buildings have been increasing at an unsustainable rate, due to much higher levels of scrutiny from certification and inspection bodies. Service penetrations through fire rated barriers, particularly where large quantities of different service types are located in ever shrinking ceiling spaces, contribute to a huge proportion of defects in walls that separate Sole Occupancy Units (SOU) and corridors, and any fire rated riser shaft wall that is used to feed services onto each floor.

The National Construction Code (NCC) does not have clear guidance on how far apart each service penetration should be when using a tested system, leading to dangerous installations where walls are butchered and patched as shown on the right hand side image. The NCC clause C3.15 allows for the use of fire tested systems using the AS1530.4 test methods, which require 200mm of separation between each service penetration during a test. Therefore, many certifying bodies and building surveyors request that service penetrations should all be 200mm apart to ensure that the FRL of the wall is not compromised. In many modern buildings, this is simply not practical...

The innovative Trafalgar FyreBOX Slab Mount system (lower right) addresses these issues but providing a single penetration that is tested to handle all common apartment, residential and commercial services through one simple penetration system. Furthermore, the two-piece design allows for the FyreBOX to be mounted prior to the walls being erected which means service trades can work faster, and the building can be completed quicker!



BENEFITS

- NCC 2022 Ready
- Thoroughly fire tested to AS1530.4-2014
- Compliance made visible
- Space saving - gives one penetration point per apartment
- Suitable for SOU and riser shaft penetrations
- Multi-service solution
- One solution for the life of the building
- Acoustic rating
- Good smoke leakage performance
- Saves time and labour for builders and service trades
- Install before the walls or after

We have had many dealings with the Trafalgar team during the growth period of our new business, and on an ongoing basis for many discussions.

They have a very knowledgeable technical team – not only on their products, but also the industry and it's issues in general. Chris has been very supportive in technical meetings at the FPA providing background, legislative interpretation, and papers etc.

John has provided many insights from historical and current experience, and we appreciate their willingness to test to remove grey areas.

Trafalgar are reliable suppliers who bridge the gap between caring about selling products and solving life safety issues.

Well done, and keep up the good work!

*Gina Patrick
Plus Passive Fire*

The FyreBOX Slab-Mount is a proudly Australian made passive fire penetration system used for multiple and mixed service penetrations which has been designed and tested to be built into residential/commercial apartment walls and riser shafts reducing the space required for service penetrations, providing predictable site costs and a reliable method of fire stopping.

Passive Fire Protection from Trafalgar Fire a Brand you can Trust, with 75 years of Innovation.

Full Product Support by the Trafalgar Fire Technical Team.



MAJOR BENEFITS WITH FIRE PROTECTION

TRUSTED FIRE SOLUTIONS / 30% LABOUR SAVINGS

The FyreBOX™ system ensures that all services are adequately fire stopped. The best permanent system and allows for service trades to complete their work faster.

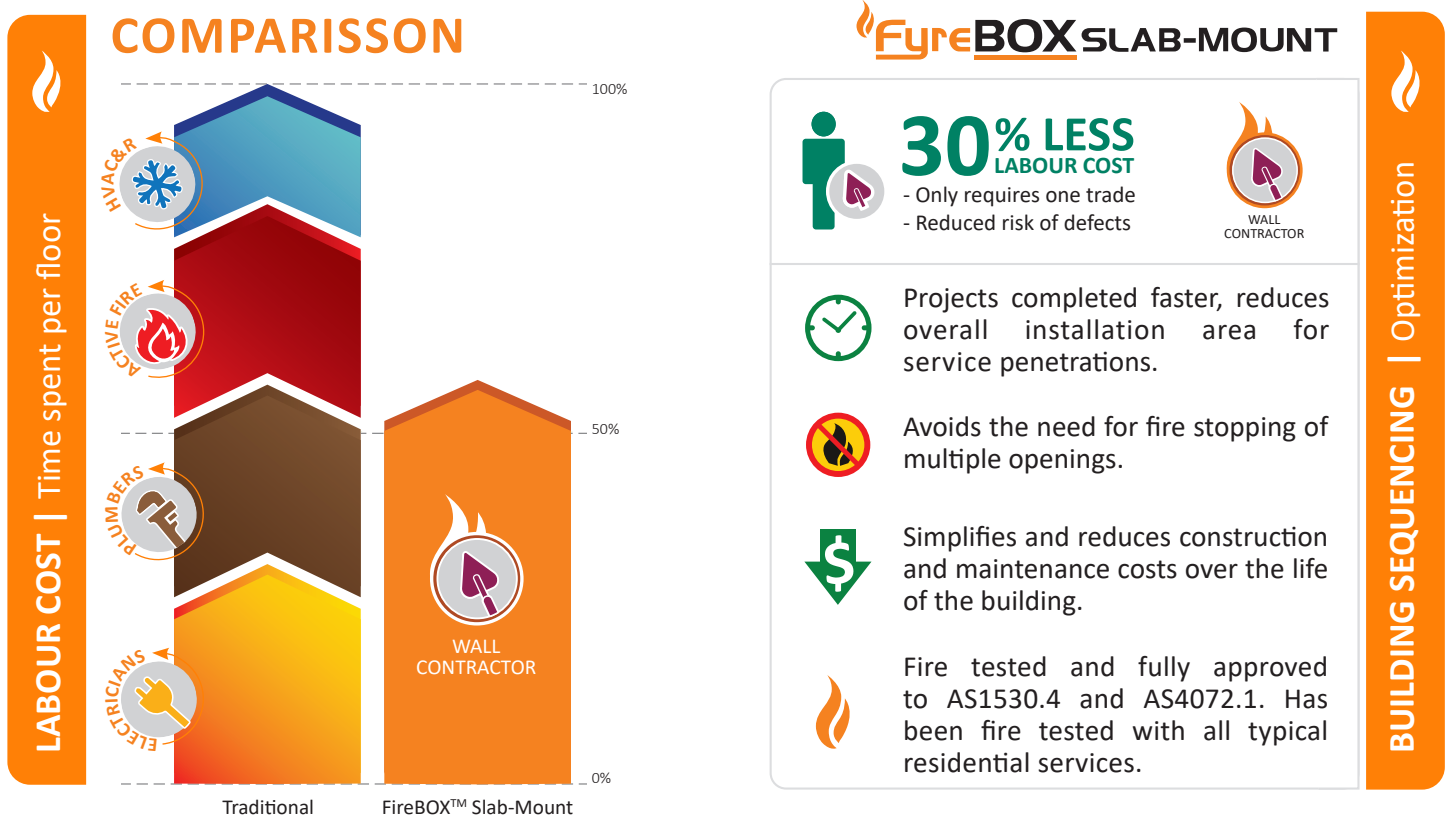

+



=



=



Click here to go back to Contents

FyreBOX SLAB-MOUNT

FyreBOX SYSTEM SELECTOR

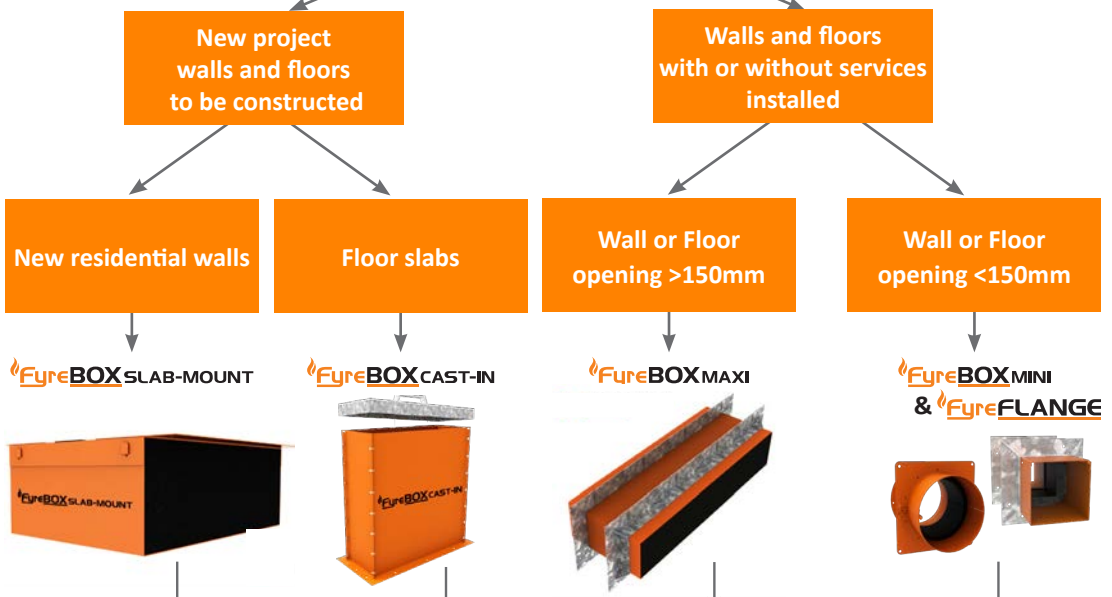

		FyreBOX SLAB-MOUNT	FyreBOX CAST-IN	FyreBOX MAXI	FyreBOX MINI & FyreFLANGE	
Installation Prior to Fire Barrier Construction		✓	✓	✗	✗	
Hole Cutting Required		✗	✗	✓	✓	
Fire Barrier	Floors	Concrete Slab	✗	✓	✓	
		FyreSET® Mortar	✗	✓	✗	✗
	Walls	Masonry Walls	✓	✗	✓	✓
		Concrete Walls	✓	✗	✓	✓
		Plasterboard	✓	✗	✓	✓
		Hebel® / Wasc®	✓	✗	✓	✓
		SpeedPanel®	✓	✗	✓	✓
		Alpha Panel®	✓	✗	✓	✓
		COREX walls	✓	✗	✓	✓
		FyreBOARD Maxilite™	✓	✗	✓	✓
	FyreBATT	✗	✗	✗	✓	
	Ceilings	Plasterboard Ceiling	✗	✗	✓	✓
		COREX ceilings	✗	✗	✓	✓
Services	Power Cables	✓	✓	✓	✓	
	Data Cables	✓	✓	✓	✓	
	Cable Trays	✓	✓	✓	✗	
	Steel and Copper Pipes	✓	✓	✓	✓	
	Aluminium Cables	✓	✓	✓	✓	
	CPVC Pipes	✓	✓	✓	✓	
	PVC Pipes	✗	✓	Floors Only	Floors Only	
	PEX	✓	✓	✓	✓	
	PEX-AL-PEX	✓	✓	✓	✓	
	Insulated Copper	✓	✓	✓	✓	
	Pair Coils	✓	✓	✓	✓	

For full FRL details please consult the relevant technical guide or contact Trafalgar Fire. Fire testing of Trafalgar Fire products is always ongoing.

FIRE RESISTANCE LEVEL

FIRE RATING – HOW IS FIRE PERFORMANCE MEASURED?

An FRL (fire resistance level) is a handy way of summarising the performance of a building element. It consists of 3 numbers, all given in minutes:

FRL 120/120/120

(example)



Structural Adequacy

The ability of the building element to support the weight of adjacent building elements.

ie: a brick wall supporting a concrete floor slab above.



Integrity

The ability of an element to prevent the passage of flames and hot gasses.

ie: a plasterboard wall remaining intact and not allowing holes to form.

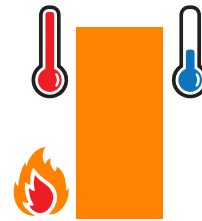

Insulation

The ability of an element to resist heat transfer from the exposed face to the unexposed face.

ie: a bundle of cables remaining below a set temperature limit on the unexposed side of the wall penetration system.

Note: Penetrations are not required to have a Structural Adequacy rating and is usually expressed as a dash. For example, a penetration through a 2 hour load bearing wall would be written as -/120/120.

INTEGRITY

The FyreBOX Slab-Mount system will achieve the integrity performance for up to 2 hours physically stopping the direct spread of fire, however the insulation performance of the penetration will be limited to the type of wall being used and conductivity of the services in the penetration.

INSULATION (TEMPERATURE RISE)

Heat transfer via conduction (or heat rise) will occur through the conductive parts of any penetration system. To limit the heat rise through the FyreBOX Slab-Mount penetration systems, our 25mm thick TWRAP™ foil encased blanket can be wrapped around the services and metal casing of the FyreBOX to achieve up to 2 hours of insulation performance. **There are some applications that won't require any TWRAP™ to achieve the full FRL, please refer to the tables below for specific details.**

60 Minute Plasterboard Stud Walls WRAP FREE

Minimum of 13mm fire grade plasterboard on each face of steel or timber stud, of minimum 64mm thickness with a stated FRL of -/60/60



**PATCH FREE!
WRAP FREE!**

Service Type	Service Specification		FRL - WRAP FREE	
			64mm stud*	92mm studs
Plastic Pipes	PVC Pipes	Up to 32mm OD	-/60/30	-/60/60
	PEX Pipes	Up to 20mm	-/60/30	-/60/60
		Up to 32mm	-/60/30	-/60/60
		Up to 32mm with 19mm E-Flex insulation	-/60/30	-/60/60
	PEX-Al-PEX pipes	Up to 25mm	-/60/30	-/60/60
		Up to 32mm	-/60/-	-/60/-*
		Up to 32mm with 19mm E-Flex insulation	-/60/30	-/60/60
cPVC Pipes	Up to 40mm	-/60/-	-/60/-*	
	40mm to 60mm	-/60/30	-/60/60	
Bare Metal Pipes	Copper	Up to 50mm	-/60/-	-/60/-*
	Steel	up to 60mm	-/60/30	-/60/60
Metal Pipes Insulated**	Copper	Up to 50mm OD with PE insulation up to 20mm thick	-/60/30	-/60/30*
		Up to 50mm OD with FR insulation	-/60/30	-/60/60
		Up to 20mm OD with 38mm rockwool-type insulation	-/60/30	-/60/60
	Pair coil	Up to 9.5 & 19mm with 20mm FR insulation (or 13mm PE)	-/60/30	-/60/60
Power Cables - Copper Core	TPS	Up to 12x 2.5mm ² per bundle	-/60/30	-/60/60
	Rigid or Flexible PVC Conduits	Up to 32mm OD (with any size power or comms cables up to 32mm diameter)	-/60/30	-/60/60
	AS1530.4 Appendix D1 cable set	Applies to copper core power cables and cable trays up to 1000mm wide	-/60/30	-/60/30*
Power Cables - Aluminium Core	Single Core cables	Bundles of up to 3 x 240mm ² , 4 x 120mm ² and 9 x 70mm ² per bundle (16x cables total)	-/60/30	-/60/30*
Communications Cables	RG6 coax	Up to 3x per bundle	-/60/30	-/60/60
	AS1530.4 Appendix D2 cable set	Applies to copper core comms cables, including cable trays up to 1000mm wide	-/60/30	-/60/60
Conduits	Rigid or Flexible PVC Conduits	Up to 32mm OD (with any size power or comms cables up to 32mm diameter)	-/60/30	-/60/60

*TWrap required on these specific services to achieve -/60/60 FRL. Refer to FC10266 for details in specific wall types.

**With or without heat trace cable.

60 Minute AAC Panels
WRAP FREE

Hebel, Wasc or other AAC panels 75mm thick when used for -/60/60 applications. **Note: 30mm Maxilite board can be laminated on one side of the penetration to increase the insulation performance without the need for TWrap as shown below (WRAP FREE).**



Service Type	Service Specification		FRL - WRAP FREE
			+ 30mm Maxilite
Plastic Pipes	PVC Pipe	Up to 32mm OD	-/60/60
	PEX Pipes	Up to 20mm	-/60/60
		Up to 32mm	-/60/60
		Up to 32mm with 19mm E-Flex insulation	-/60/60
	PEX-Al-PEX pipes	Up to 25mm	-/60/60
		Up to 32mm	-/60/-*
		Up to 32mm with 19mm E-Flex insulation	-/60/60
	cPVC Pipes	Up to 40mm	-/60/-*
40mm to 60mm		-/60/60	
Bare Metal Pipes	Copper	Up to 50mm	-/60/-*
	Steel	up to 60mm	-/60/60
Metal Pipes Insulated**	Copper	Up to 50mm OD with PE insulation up to 20mm thick	-/60/60
		Up to 50mm OD with FR insulation	-/60/60
	Pair coil	Up to 20mm OD with 38mm rockwool-type insulation	-/60/60
		Up to 9.5 & 19mm with 13mm PE insulation	-/60/60
Power Cables - Copper Core	TPS	Up to 9.5 & 19mm with 20mm FR insulation	-/60/60
		Up to 12x 2.5mm ² per bundle	-/60/60
	Rigid or Flexible PVC Conduits	Up to 32mm OD (with any size power or comms cables up to 32mm diameter)	-/60/60
Power Cables Aluminium Core	AS1530.4 Appendix D1 cable set	Applies to copper core power cables and cable trays up to 1000mm wide	-/60/30*
	Single Core cables	Bundles of up to 3 x 240mm ² , 4 x 120mm ² and 9 x 70mm ² per bundle (16x cables total)	-/60/30*
Communications Cables	RG6 coax	Up to 3x per bundle	-/60/60
	AS1530.4 Appendix D2 cable set	Applies to copper core comms cables, including cable trays up to 1000mm wide	-/60/60
Conduits	Rigid or Flexible PVC Conduits	Up to 32mm OD (with any size power or comms cables up to 32mm diameter)	-/60/60

*TWrap required on these specific services to achieve -/60/60 FRL. Refer to FC10266 for details in specific wall types.
**With or without heat trace cable.

60 Minute Concrete, Masonry and Permanent Formwork Walls: Wrap Free

Walls designed as per AS3600 or AS3700 (or otherwise fire tested to achieved the required FRL with a minimum thickness as per the 90mm) including Dintel, AFS, Logically etc.



Service Type	Service Specification		FRL (Wrap Free)
Plastic Pipes	PVC Pipes	Up to 32mm OD	-/60/60
	PEX Pipes	Up to 20mm	-/60/60
		Up to 32mm	-/60/60
	PEX-Al-PEX pipes	Up to 20mm	-/60/60
		Up to 25mm	-/60/60
		Up to 32mm	-/60/*
	cPVC Pipes	Up to 40mm	-/60/*
40mm to 60mm		-/60/60	
Bare Metal Pipes	Copper	Up to 50mm	-/60/*
	Steel	up to 60mm	-/60/60
Metal Pipes Insulated**	Copper	Up to 50mm OD with PE insulation up to 20mm thick	-/60/60
		Up to 50mm OD with FR insulation	-/60/60
		Up to 20mm OD with 38mm rockwool-type insulation	-/60/60
	Pair coil	Up to 9.5 & 19mm with 13mm FR insulation	-/60/60
		Up to 9.5 & 19mm with 20mm FR insulation	-/60/60
Power Cables - Copper Core	TPS	Up to 12x 2.5mm ² per bundle	-/60/60
	Rigid or Flexible PVC Conduits	Up to 32mm OD (with any size power or comms cables up to 32mm diameter)	-/60/60
	AS1530.4 Appendix D1 cable set	Applies to copper core power cables and cable trays up to 1000mm wide	-/60/60
Power Cables Aluminium Core	Single Core cables	Bundles of up to 3 x 240mm ² , 4 x 120mm ² and 9 x 70mm ² per bundle (16x cables total)	-/60/60
Communications Cables	RG6 coax	Up to 3x per bundle	-/60/60
	AS1530.4 Appendix D2 cable set	Applies to copper core comms cables, including cable trays up to 1000mm wide	-/60/60

*TWrap required on these specific services to achieve -/60/60 FRL. Refer to FC10266 for details in specific wall types.

**With or without heat trace cable.

60 minute IntrWall & Other Party Wall Systems

FyreBOX can penetrate the core of the wall, which is laminated with at least 1x16mm fire grade plasterboard on one side (or 1x layer of 13mm on both sides of the shaftliner core).



Service Type	Service Specification		FRL Wrap Free*	FRL with TWRAP™	TWrap Length required (mm)
Plastic Pipes	PVC Pipes	Up to 32mm OD	-/60/30	-/60/60	300
	PEX Pipes	Up to 20mm	-/60/30		300
		Up to 32mm	-/60/30		450
		Up to 32mm with 19mm E-Flex insulation	-/60/30		300
	PEX-Al-PEX pipes	Up to 25mm	-/60/30		300
		Up to 32mm	-/60/-		450
		Up to 32mm with 19mm E-Flex insulation	-/60/30		300
	cPVC Pipes	Up to 40mm	-/60/-		300
40mm to 60mm		-/60/30	300		
Bare Metal Pipes	Copper	Up to 50mm	-/60/-		300
	Steel	up to 60mm	-/60/30		300
Metal Pipes Insulated**	Copper	Up to 50mm OD with PE insulation up to 20mm thick	-/60/30		300
		Up to 50mm OD with FR insulation	-/60/30		300
		Up to 20mm OD with 38mm rockwool-type insulation	-/60/30		300
	Pair coil	Up to 9.5 & 19mm with 20mm FR insulation (or 13mm PE)	-/60/30	300	
Power Cables - Copper Core	TPS	Up to 12x 2.5mm ² per bundle	-/60/30	300	
	AS1530.4 Appendix D1 cable set	Applies to copper core power cables and cable trays up to 1000mm wide	-/60/30	300	
Power Cables - Aluminium Core	Single Core cables	Bundles of up to 3 x 240mm ² , 4 x 120mm ² and 9 x 70mm ² per bundle (16x cables total)	-/60/30	300	
Communications Cables	RG6 coax	Up to 3x per bundle	-/60/30	300	
	AS1530.4 Appendix D2 cable set	Applies to copper core comms cables, including cable trays up to 1000mm wide	-/60/30	300	
Conduits	Rigid or Flexible PVC Conduits	Up to 32mm OD (with or without cables)	-/60/30	300	

*If using FyreBOX without TWrap for FRL's up to -/60/30, the wall must be thickened with 60mm Maxilite board 100mm strips on one side.

**Heat trace cables may be installed underneath thermal lagging through a FyreBOX penetration

60 minute XCEM Alpha Panel walls

Type 1 - 35mm Alpha Panel, framed with stud and lined on the other face with 13mm fire grade plasterboard (88mm minimum thickness)

Type 2 - 35mm Alpha Panel, framed with stud on both sides, lined on both faces with 13mm fire grade plasterboard (200mm minimum thickness)



Service Type	Service Specification		FRL - WRAP FREE		FRL with TWRAP™	
			Type 1	Type 2	Both walls	Length required (mm)
Plastic Pipes	PVC Pipes	Up to 32mm OD	-/60/30	-/60/60		300
	PEX Pipes	Up to 20mm	-/60/30	-/60/60		300
		Up to 32mm	-/60/30	-/60/60		450
		Up to 32mm with 19mm E-Flex	-/60/30	-/60/60		300
	PEX-Al-PEX pipes	Up to 25mm	-/60/30	-/60/60		300
		Up to 32mm	-/60/-	-/60/-		450
		Up to 32mm with 19mm E-Flex	-/60/30	-/60/60		300
	cPVC Pipes	Up to 40mm	-/60/-	-/60/-		300
40mm to 60mm		-/60/30	-/60/60	300		
Bare Metal Pipes	Copper	Up to 50mm	-/60/-	-/60/-	300	
	Steel	up to 60mm	-/60/30	-/60/60	300	
Metal Pipes Insulated*	Copper	Up to 50mm OD with PE insulation up to 20mm thick	-/60/30	-/60/30	-/60/60	300
		Up to 50mm OD with FR insulation	-/60/30	-/60/60		300
		Up to 20mm OD with 38mm rockwool-type insulation	-/60/30	-/60/60		300
	Pair coil	Up to 9.5 & 19mm with 20mm FR insulation (or 13mm PE)	-/60/30	-/60/60		300
Power Cables - Copper Core	TPS	Up to 12x 2.5mm ² per bundle	-/60/30	-/60/60	300	
	AS1530.4 Appendix D1 cable set	Applies to copper core power cables and cable trays up to 1000mm wide	-/60/30	-/60/30	300	
Power Cables Aluminium Core	Single Core cables	Bundles of up to 3 x 240mm ² , 4 x 120mm ² and 9 x 70mm ² per bundle (16x cables total)	-/60/30	-/60/30	300	
Communications Cables	RG6 coax	Up to 3x per bundle	-/60/30	-/60/60	300	
	AS1530.4 Appendix D2 cable set	Applies to copper core comms cables, including cable trays up to 1000mm wide	-/60/30	-/60/60	300	
Conduits	Rigid or Flexible PVC Conduits	Up to 32mm OD (with or without cables)	-/60/30	-/60/60	300	

*Heat trace cables may be installed underneath thermal lagging through a FyreBOX penetration

90 Minute AAC Panels

Hebel, Waslc or other AAC panels 75mm thick with a stated FRL up to -/90/90. Note if this wall is used for a -/60/60 apartment entry, please refer to page 9.

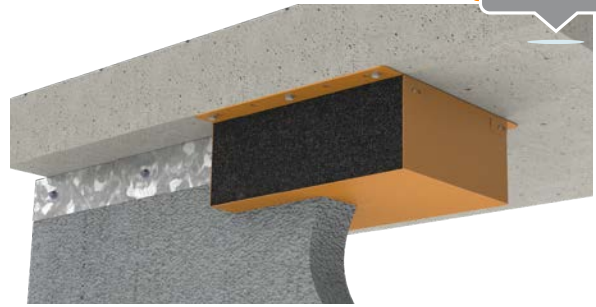

Service Type	Service Specification		FRL - WRAP FREE	FRL-With 300mm TWRAP
Plastic Pipes	PVC Pipes	Up to 32mm OD	-/90/30	-/90/90
	PEX Pipes	Up to 20mm	-/90/30	-/90/90
		Up to 32mm	-/90/30	-/90/90 (450mm TWrap)
		Up to 32mm with 19mm E-Flex insulation	-/90/30	-/90/90
	PEX-Al-PEX pipes	Up to 20mm	-/90/30	-/90/90
		Up to 25mm	-/90/30	-/90/90
		Up to 32mm	-/90/0	-/90/90 (450mm TWrap)
		Up to 32mm with 19mm E-Flex insulation	-/90/30	-/90/90
	cPVC Pipes	Up to 40mm	-/90/0	-/90/90
		40mm to 60mm	-/90/30	-/90/90
Bare Metal Pipes	Copper	Up to 50mm	-/90/0	-/90/90
	Steel	up to 60mm	-/90/30	-/90/90
Metal Pipes Insulated*	Copper	Up to 50mm OD with PE insulation up to 20mm thick	-/90/30	-/90/90
		Up to 50mm OD with FR insulation	-/90/30	-/90/90
		Up to 20mm OD with 38mm rockwool-type insulation	-/90/30	-/90/90
	Pair coil	Up to 9.5 & 19mm with 13mm PE insulation	-/90/30	-/90/90
		Up to 9.5 & 19mm with 20mm FR insulation	-/90/30	-/90/90
Power Cables - Copper Core	TPS	Up to 12x 2.5mm ² per bundle	-/90/30	-/90/90
	AS1530.4 Appendix D1 cable set	Applies to copper core power cables and cable trays up to 1000mm wide	-/90/30	-/90/90
	Rigid or Flexible PVC Conduits	Up to 32mm OD (with any size power or comms cables up to 32mm diameter)	-/90/30	-/90/90
Power Cables Aluminium Core	Single Core cables	Bundles of up to 3 x 240mm ² , 4 x 120mm ² and 9 x 70mm ² per bundle (16x cables total)	-/90/30	-/90/90
Communications Cables	RG6 coax	Up to 3x per bundle	-/90/30	-/90/90
	AS1530.4 Appendix D2 cable set	Applies to copper core comms cables, including cable trays up to 1000mm wide	-/90/30	-/90/90

*With or without heat trace cable

90 Minute Plasterboard Stud Walls

Minimum of 16mm fire grade plasterboard on each face of a steel or timber stud of minimum 64mm thickness, with a stated FRL of -/90/90.



Service Type	Service Specification		FRL (Wrap Free)	FRL with TWRAP™	TWRAP™ Length required (mm)
Plastic Pipes	PVC Pipes	Up to 32mm OD	-/90/60	-/90/90	300
	PEX Pipes	Up to 20mm	-/90/60		300
		Up to 32mm	-/90/60		450
		Up to 32mm with 19mm E-Flex insulation	-/90/60		300
		Up to 25mm	-/90/60		300
	PEX-Al-PEX pipes	Up to 32mm	-/90/-		450
		Up to 32mm with 19mm E-Flex insulation	-/90/30		300
		cPVC Pipes	Up to 40mm		-/90/-
	40mm to 60mm		-/90/60		300
	Bare Metal Pipes	Copper	Up to 50mm		-/90/-
Steel		up to 60mm	-/90/30	300#	
Metal Pipes Insulated*	Copper	Up to 50mm OD with PE insulation up to 20mm thick	-/90/30	300	
		Up to 50mm OD with FR insulation	-/90/30	300	
		Up to 20mm OD with 38mm rockwool-type insulation	-/90/30	300	
	Pair coil	Up to 9.5 & 19mm with 20mm FR insulation (or 13mm PE)	-/90/30	300	
Power Cables - Copper Core	TPS	Up to 12x 2.5mm ² per bundle	-/90/30	300	
	AS1530.4 Appendix D1 cable set	Applies to copper core power cables and cable trays up to 1000mm wide	-/90/30	300	
Power Cables Aluminium Core	Single Core cables	Bundles of up to 3 x 240mm ² , 4 x 120mm ² and 9 x 70mm ² per bundle (16x cables total)	-/90/30	300	
Communications Cables	RG6 coax	Up to 3x per bundle	-/90/30	300	
	AS1530.4 Appendix D2 cable set	Applies to copper core comms cables, including cable trays up to 1000mm wide	-/90/30	300	
Conduits	Rigid or Flexible PVC Conduits	Up to 32mm OD (with or without cables)	-/90/60	300	

*Heat trace cables may be installed underneath thermal lagging through a FyreBOX penetration
 #With 300mm of loose TWRap infill packed around any cable tray services within the wrap.

90 Minute Laminated Plasterboard Shaft Walls

Minimum of 3x fire grade plasterboard on one side of a steel stud with a stated FRL of 90 or 120 minutes. FyreBOX penetration thickened with 60mm Maxilite in 100mm strips on one side of the penetration.

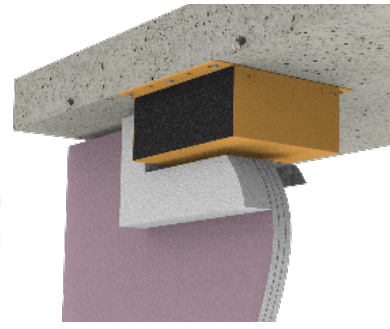

FRL TABLES - Laminated Plasterboard 90 - 120 MIN

Service Type	Service Specification		Plasterboard outside minimum 64mm stud (FRL wrap Free)		FRL with TWRAP	TWRap Length required (mm)
			3x13mm plaster	3x16mm plaster		
Plastic Pipes	PVC Conduits	Up to 32mm OD	-/90/30	-/120/30	-/120/120 (Limited to the FRL of the wall)	300
	PEX Pipes	Up to 20mm	-/90/30	-/120/30		300
		Up to 32mm	-/90/30	-/120/30		450
		Up to 32mm with 19mm E-Flex insulation	-/90/30	Not approved		300 (-/90/90 only)
	PEX-Al-PEX pipes	Up to 25mm	-/90/30	-/120/30		450
		Up to 32mm	-/90/-	-/120/30		450
		Up to 32mm with 19mm E-Flex insulation	-/90/30	Not approved		300 (-/90/90 only)
	cPVC Pipes	Up to 40mm	-/90/-	-/120/-		300
		40mm to 60mm	-/90/30	-/120/30		300
	Bare Metal Pipes	Copper	Up to 50mm	-/90/-		-/120/-
Steel		up to 60mm	-/90/30	-/120/30	300	
Metal Pipes Insulated**	Copper	Up to 50mm OD with PE insulation up to 20mm thick	-/90/30	-/120/30	300	
		Up to 50mm OD with FR insulation	-/90/30	-/120/30	300	
		Up to 20mm OD with 38mm rockwool-type insulation	-/90/30	-/120/30	300	
	Pair coil	Up to 9.5 & 19mm with 20mm FR insulation (or 13mm PE)	-/90/30	-/120/30	300	
Power Cables - Copper Core	TPS	Up to 12x 2.5mm ² per bundle	-/90/30	-/120/30	300	
	AS1530.4 Appendix D1 cable set	Applies to copper core power cables and cable trays up to 1000mm wide	-/90/30	-/120/30	600**	
Power Cables Aluminium Core	Single Core cables	Bundles of up to 3 x 240mm ² , 4 x 120mm ² and 9 x 70mm ² per bundle (16x cables total)	-/90/30	-/120/30	300	
Communications Cables	RG6 coax	Up to 3x per bundle	-/90/30	-/120/30	300	
	AS1530.4 Appendix D2 cable set	Applies to copper core comms cables, including cable trays up to 1000mm wide	-/90/30	-/120/30	450	
Conduits	Rigid or Flexible PVC Conduits	Up to 32mm OD (with or without cables)	-/90/30	-/120/30	300	

*Heat trace cables may be installed underneath thermal lagging through a FyreBOX penetration

**Loose TWRap infill installed onto cable trays for at least 300mm underneath TWRap

90 minute XCEM Alpha Panel walls



Type 3 - 35mm Alpha Panel, framed with stud and lined on the other face with 16mm fire grade plasterboard (91mm minimum thickness).

Type 4 - 35mm Alpha Panel laminated with 16mm fire grade plasterboard.

Service Type	Service Specification		FRL (Wrap Free)**		FRL with TWRAP™	
			Type 3	Type 4	Both walls	Length required (mm)
Plastic Pipes	PVC Conduits	Up to 32mm OD	-/90/60	-/90/30	-/90/90	450
	PEX Pipes	Up to 20mm	-/90/60	-/90/30		450
		Up to 32mm	-/90/60	-/90/30		450
		Up to 32mm with 19mm E-Flex	-/90/60	-/90/30		450
	PEX-Al-PEX pipes	Up to 25mm	-/90/60	-/90/30		450
		Up to 32mm	-/90/-	-/90/-		450
		Up to 32mm with 19mm E-Flex insulation	-/90/30	-/90/30		450
	cPVC Pipes	Up to 40mm	-/90/-	-/90/-		450
40mm to 60mm		-/90/60	-/90/30	450		
Bare Metal Pipes	Copper	Up to 50mm	-/90/-	-/90/30		450
	Steel	up to 60mm	-/90/30	-/90/30		450
Metal Pipes Insulated*	Copper	Up to 50mm OD with PE insulation up to 20mm thick	-/90/30	-/90/30		450
		Up to 50mm OD with FR insulation	-/90/30	-/90/30		450
		Up to 20mm OD with 38mm rockwool-type insulation	-/90/30	-/90/30		450
	Pair coil	Up to 9.5 & 19mm with 20mm FR insulation (or 13mm PE)	-/90/30	-/90/30		450
Power Cables - Copper Core	TPS	Up to 12x 2.5mm ² per bundle	-/90/30	-/90/30		450
	AS1530.4 Appendix D1 cable set	Applies to copper core power cables and cable trays up to 1000mm wide	-/90/30	-/90/30	450	
Power Cables Aluminium Core	Single Core cables	Bundles of up to 3 x 240mm ² , 4 x 120mm ² and 9 x 70mm ² per bundle (16x cables total)	-/90/30	-/90/30	450	
Communications Cables	RG6 coax	Up to 3x per bundle	-/90/30	-/90/30	450	
	AS1530.4 Appendix D2 cable set	Applies to copper core comms cables, including cable trays up to 1000mm wide	-/90/30	-/90/30	450	
Conduits	Rigid or Flexible PVC Conduits	Up to 32mm OD (with or without cables)	-/90/60	-/90/30	450	

*Heat trace cables may be installed underneath thermal lagging through a FyreBOX penetration
 **Wrap free FRL's require a patch of 60mm Maxilite board 100mm strips on one side of the wall.

120 Minute Plasterboard Stud Walls

Minimum of 2x13mm fire grade plasterboard on each face of steel or timber stud, of minimum 64mm thickness with a stated FRL of -/120/120.



Service Type	Service Specification		FRL (Wrap Free)	FRL with TWRAP™ (all studs)	TWRAP™ Length required (mm)
Plastic Pipes	PVC Pipes	Up to 32mm OD	-/120/60	-/120/120	300
	PEX Pipes	Up to 20mm	-/120/60		300
		Up to 32mm	-/120/60		450
	PEX-Al-PEX pipes	Up to 20mm	-/120/60		300
		Up to 32mm	-/120/-		450
	cPVC Pipes	Up to 40mm	-/120/-		300
40mm to 60mm		-/120/60	300		
Bare Metal Pipes	Copper	Up to 50mm	-/120/-		300
	Steel	up to 60mm	-/120/60		300
Metal Pipes Insulated*	Copper	Up to 50mm OD with PE insulation up to 20mm thick	-/120/60		300
		Up to 50mm OD with FR insulation	-/120/60		300
		Up to 20mm OD with 38mm rockwool-type insulation	-/120/60		300
	Pair coil	Up to 9.5 & 19mm with 20mm FR insulation (or 13mm PE)	-/120/60	300	
Power Cables - Copper Core	TPS	Up to 12x 2.5mm ² per bundle	-/120/60	300	
	AS1530.4 Appendix D1 cable set	Applies to copper core power cables and cable trays up to 1000mm wide	-/120/60	600**	
Power Cables Aluminium Core	Single Core cables	Bundles of up to 3 x 240mm ² , 4 x 120mm ² and 9 x 70mm ² per bundle (16x cables total)	-/120/30	300	
Communications Cables	RG6 coax	Up to 3x per bundle	-/120/60	300	
	AS1530.4 Appendix D2 cable set	Applies to copper core comms cables, including cable trays up to 1000mm wide	-/120/60	450**	
Conduits	Rigid or Flexible PVC Conduits	Up to 32mm OD (with or without cables)	-/120/60	300	

*Heat trace cables may be installed underneath thermal lagging through a FyreBOX penetration

**Loose TWrap infill installed onto cable trays for at least 300mm underneath TWrap

120 Minute Concrete, Masonry and Permanent Formwork Walls



Walls designed as per AS3600 or AS3700 (or otherwise fire tested to achieved the required FRL with a minimum thickness as per the 90mm) including Dintel, AFS, Logicalc etc.

Service Type	Service Specification		FRL (Wrap Free)	FRL with TWRAP™ (all studs)	TWRAP™ Length required (mm)
Plastic Pipes	PVC Pipes	Up to 32mm OD	-/120/60	-/120/120	300
	PEX Pipes	Up to 20mm	-/120/60		300
		Up to 32mm	-/120/60		450
	PEX-Al-PEX pipes	Up to 20mm	-/120/60		300
		Up to 25mm	-/120/60		450
		Up to 32mm	-/120/0		450
	cPVC Pipes	Up to 40mm	-/120/0		300
		40mm to 60mm	-/120/60		300
Bare Metal Pipes	Copper	Up to 50mm	-/120/0		300
	Steel	up to 60mm	-/120/60		300
Metal Pipes Insulated*	Copper	Up to 50mm OD with PE insulation up to 20mm thick	-/120/60		300
		Up to 50mm OD with FR insulation	-/120/60		300
		Up to 20mm OD with 38mm rockwool-type insulation	-/120/60		300
	Pair coil	Up to 9.5 & 19mm with 13mm FR insulation	-/120/60		300
		Up to 9.5 & 19mm with 20mm FR insulation	-/120/60	300	
Power Cables - Copper Core	TPS	Up to 12x 2.5mm ² per bundle	-/120/60	300	
	AS1530.4 Appendix D1 cable set	Applies to copper core power cables and cable trays up to 1000mm wide	-/120/60	600#	
Power Cables Aluminium Core	Single Core cables	Bundles of up to 3 x 240mm ² , 4 x 120mm ² and 9 x 70mm ² per bundle (16x cables total)	-/120/30	300	
Communications Cables	RG6 coax	Up to 3x per bundle	-/120/60	300	
	AS1530.4 Appendix D2 cable set	Applies to copper core comms cables, including cable trays up to 1000mm wide	-/120/60	450#	
Conduits	Rigid or Flexible PVC Conduits	Up to 32mm OD (with or without cables)	-/120/60	300	

*With or without heat trace cable.

#With 300mm of loose TWRap infill packed around any cable tray services within the wrap.

120 Minute AAC Panels

Hebel, Wasc or other AAC panels 75mm thick with a stated FRL up to -/120/120.



Service Type	Service Specification		FRL (Wrap Free)	FRL with TWRAP™	TWRAP™ Length required (mm)
Plastic Pipes	PVC pipes	Up to 32mm OD	-/120/30	-/120/120	300
	PEX Pipes	Up to 20mm	-/120/30		300
		Up to 32mm	-/120/30		450
	PEX-Al-PEX pipes	Up to 20mm	-/120/30		300
		Up to 25mm	-/120/30		450
		Up to 32mm	-/120/0		450
	cPVC Pipes	Up to 40mm	-/120/0		300
		Up to 60mm	-/120/30		300
Bare Metal Pipes	Copper	Up to 50mm	-/120/0		300
	Steel	up to 60mm	-/120/30		300
Metal Pipes Insulated*	Copper	Up to 50mm OD with PE insulation up to 20mm thick	-/120/30		300
		Up to 50mm OD with FR insulation	-/120/30		300
	Pair coil	Up to 20mm OD with 38mm rockwool-type insulation	-/120/30	300	
		Up to 9.5 & 19mm with 13mm FR insulation	-/120/30	300	
		Up to 9.5 & 19mm with 20mm FR insulation	-/120/30	300	
Power Cables - Copper Core	TPS	Up to 12x 2.5mm ² per bundle	-/120/30	300	
	AS1530.4 Appendix D1 cable set	Applies to copper core power cables and cable trays up to 1000mm wide	-/120/30	600#	
Power Cables Aluminium Core	Single Core cables	Bundles of up to 3 x 240mm ² , 4 x 120mm ² and 9 x 70mm ² per bundle (16x cables total)	-/120/30	300	
Communications Cables	RG6 coax	Up to 3x per bundle	-/120/30	300	
	AS1530.4 Appendix D2 cable set	Applies to copper core comms cables, including cable trays up to 1000mm wide	-/120/30	450#	
Conduits	Rigid or Flexible PVC Conduits	Up to 32mm OD (with or without cables)	-/120/60	300	

*With or without heat trace cable

#With 300mm of loose TWRap infill packed around the services within the wrap.

Speedpanel® Walls

Speedpanel walls of thickness ranging from 51mm (-/60/60), 64mm (-/90/90) and 78mm (-/120/120).

Note 51mm and 64mm Speedpanel walls required additional patch of 30mm Maxilite board on one side of the wall.



Service Type	Service Specification		51mm Speedpanel + 30mm Maxilite	64mm Speedpanel + 30mm Maxilite	78mm Speedpanel	TWrap Length required (mm)
Plastic Pipes	PVC pipes	Up to 32mm OD	-/60/60	-/90/90	-/120/120	300
	PEX Pipes	Up to 20mm				300
		Up to 32mm				450
		Up to 32mm with 19mm E-Flex**				450
	PEX-AL-PEX pipes	Up to 20mm				300
		Up to 32mm				450
		Up to 32mm with 19mm E-Flex**				450
cPVC Pipes	Up to 40mm	300				
	Up to 60mm	300				
Bare Metal Pipes	Copper	Up to 50mm				300
	Steel	up to 60mm				300
Metal Pipes Insulated#	Copper	Up to 50mm OD with PE insulation up to 20mm thick				300
		Up to 50mm OD with FR insulation				300
		Up to 20mm OD with 38mm rockwool-type insulation				300
	Pair coil	Up to 9.5 & 19mm with 13mm PE insulation	300			
		Up to 9.5 & 19mm with 20mm FR insulation	300			
Power Cables - Copper Core	TPS	Up to 12x 2.5mm ² per bundle	300			
	AS1530.4 Appendix D1 cable set	Applies to copper core power cables and cable trays up to 1000mm wide	600*			
Power Cables Aluminium Core	Single Core cables	Bundles of up to 3 x 240mm ² , 4 x 120mm ² and 9 x 70mm ² per bundle (16x cables total)	300			
Communications Cables	RG6 coax	Up to 3x per bundle	300			
	AS1530.4 Appendix D2 cable set	Applies to copper core comms cables, including cable trays up to 1000mm wide	450*			
Conduits	Rigid or Flexible PVC Conduits	Up to 32mm OD (with or without cables)	300			

*300mm loose TWrap infill underneath TWrap

** Maximum FRL-/90/90

#With or without heat trace cable

For specific service based FRL's without using TWrap, refer to report FC10266

Trafalgar COREX Shaft Walls

2x laminated Corex boards fixed to one side of a 64mm steel stud. FRL of the wall is related to thickness of the Corex facings as shown in the table. [Click here for the Corex Shaft Wall technical Manual.](#)

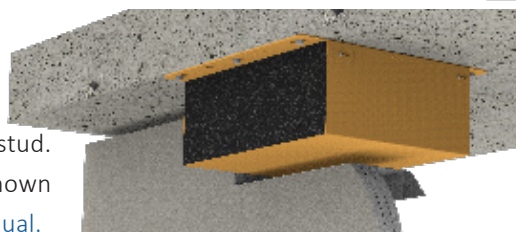

Service Type	Service Specification		Corex Board Specification & FyreBOX Penetration FRL*			TWrap Length required (mm)
			2x15mm	2x20mm	2x25mm	
Plastic Pipes	PVC Pipes	Up to 32mm OD	-/60/60	-/90/90	-/120/120	450
	PEX Pipes	Up to 20mm				450
		Up to 32mm				450
		Up to 32mm with 19mm E-Flex insulation				450
		Up to 20mm				450
	PEX-Al-PEX pipes	Up to 25mm				450
		Up to 32mm				450
		Up to 32mm with 19mm E-Flex insulation				450
		cPVC Pipes				Up to 40mm
	40mm to 60mm					450
Bare Metal Pipes	Copper	Up to 50mm	-/60/60	-/90/90	-/120/120	450
	Steel	up to 60mm				450
Metal Pipes Insulated**	Copper	Up to 50mm OD with PE insulation up to 20mm thick	-/60/60	-/90/90	-/120/120	450
		Up to 50mm OD with FR insulation				450
		Up to 20mm OD with 38mm rockwool-type insulation				450
	Pair coil	Up to 9.5 & 19mm with 13mm PE insulation				450
		Up to 9.5 & 19mm with 20mm FR insulation				450
Power Cables - Copper Core	TPS	Up to 12x 2.5mm ² per bundle	-/60/60	-/90/90	-/120/120	450
	AS1530.4 Appendix D1 cable set	Applies to copper core power cables and cable trays up to 1000mm wide				450
Power Cables Aluminium Core	Single Core cables	Bundles of up to 3 x 240mm ² , 4 x 120mm ² and 9 x 70mm ² per bundle (16x cables total)	-/60/60	-/90/90	-/120/120	450
Communications Cables	RG6 coax	Up to 3x per bundle	-/60/60	-/90/90	-/120/120	450
	AS1530.4 Appendix D2 cable set	Applies to copper core comms cables, including cable trays up to 1000mm wide				450
Conduits	Rigid or Flexible PVC Conduits	Up to 32mm OD (with or without cables)	-/60/60	-/90/90	-/120/120	450

For Corex walls, the wall must be thickened on one side with 100mm wide Maxilite, 60mm thick around the penetration.

*For specific service based FRL's without using TWrap, refer to report FC10266.

**Heat trace cables may be installed underneath thermal lagging through a FyreBOX penetration

Maxilite Board Bulkheads and Oversized Penetrations

Maxilite FyreBOARD is commonly used to construct fire rated bulkheads or to seal oversized apertures cut into fire walls. Minimum thickness required 60mm. [Click here for the Maxilite technical manuals.](#)

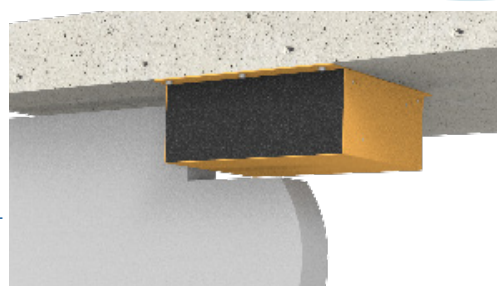

Service Type	Service Specification		FRL (Wrap Free)	FRL with TWRAP™ (all studs)	TWRAP™ Length required (mm)
Plastic Pipes	PVC Pipes	Up to 32mm OD	-/120/30	-/120/120	300
	PEX Pipes	Up to 20mm	-/120/30		300
		Up to 32mm	-/120/30		450
	PEX-Al-PEX pipes	Up to 20mm	-/120/30		300
		Up to 25mm	-/120/30		450
		Up to 32mm	-/120/0		450
	cPVC Pipes	Up to 40mm	-/120/0		300
40mm to 60mm		-/120/30	300		
Bare Metal Pipes	Copper	Up to 50mm	-/120/0		300
	Steel	up to 60mm	-/120/30		300
Metal Pipes Insulated*	Copper	Up to 50mm OD with PE insulation up to 20mm thick	-/120/30		300
		Up to 50mm OD with FR insulation	-/120/30		300
		Up to 20mm OD with 38mm rockwool-type insulation	-/120/30		300
	Pair coil	Up to 9.5 & 19mm with 13mm FR insulation	-/120/30		300
		Up to 9.5 & 19mm with 20mm FR insulation	-/120/30	300	
Power Cables - Copper Core	TPS	Up to 12x 2.5mm ² per bundle	-/120/30	300	
	AS1530.4 Appendix D1 cable set	Applies to copper core power cables and cable trays up to 1000mm wide	-/120/30	600#	
Power Cables Aluminium Core	Single Core cables	Bundles of up to 3 x 240mm ² , 4 x 120mm ² and 9 x 70mm ² per bundle (16x cables total)	-/120/30	300	
Communications Cables	RG6 coax	Up to 3x per bundle	-/120/30	300	
	AS1530.4 Appendix D2 cable set	Applies to copper core comms cables, including cable trays up to 1000mm wide	-/120/30	450#	
Conduits	Rigid or Flexible PVC Conduits	Up to 32mm OD (with or without cables)	-/120/30	300	

*With or without heat trace cable

#With 300mm of loose TWrap infill packed around the services within the wrap.

INSTALLATION STAGE 1: Slab-Mount the FyreBOX

ALL WALLS

MARK

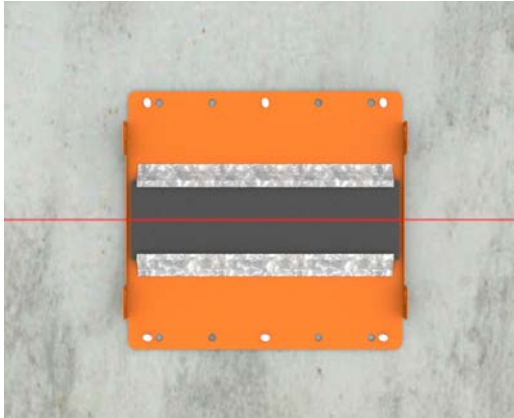

Mark the location where the wall is to be constructed and position the FyreBOX Slab-Mount in the desired penetration position.

Ensure that the FyreBOX will be located centrally to the thickness of the wall.

SEPARATE



Separate the bottom section of the FyreBOX, and the foam end plugs, which are to be put in a safe location for later use.

FIX



Fix the top section of the FyreBOX to the floor slab using **M6 masonry anchors, 4mm gas or powder actuated anchors** or any other **all-steel anchor** of equal pull out rating through the pre-formed mounting holes at two per side, or 300mm centres.

SERVICES



Install services through the FyreBOX as required, ensuring all are approved for use. Please refer to the FRL tables for a list of all approved services (NB extra services can be installed at any stage of the FyreBOX installation).

Click to Watch Installation Video



INSTALLATION STAGE 2: WALL INSTALLATION

PLASTERBOARD AND COREX

CLOSE



Retrieve the bottom section of the FyreBOX and fit around the services, to the secured top section, confirming that all fixing tabs are properly locked into place.

FRAME



Install the wall's stud framing around the perimeter of the FyreBOX and fix the plasterboard as per the wall manufacturers instruction, ensuring the annular gaps between the FyreBOX and **wall openings are within 5-20mm and allow for deflection as required.**

There is no need to line the opening around a FyreBOX with plasterboard for 60 minute applications.

Corex Walls require the opening to be lined with the same thickness of Corex board as is used to build the wall.

PLASTER



Plasterboard is applied around the FyreBOX Slab-Mount, forming annular gaps maximum 20mm. For Corex walls, the wall must be thickened on one side with 100mm wide Maxilite, 60mm thick around the penetration.

FINISHING

Complete the installation by following the Stages 3-4 steps outlined on [pages 28-29](#)

Click to Watch Installation Video



INSTALLATION STAGE 2: WALL INSTALLATION

AAC PANEL WALL

ANGLES

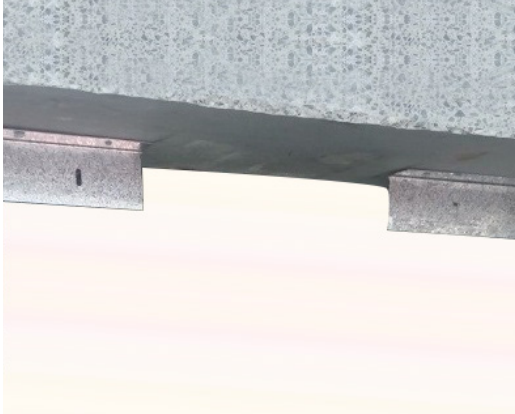

Install the Hebel® wall's fixing angles on either side of the FyreBOX

PANEL



Install the Hebel® wall panel as per the supplier's instructions, ensuring the annular gaps between the FyreBOX and wall opening are within 5-20mm.

Please note: FyreBOARD Maxilite® collar is not needed if you are planning to use the 3 – sided TWRAP™ detail which covers the casing of the FyreBOX for 90-minute insulation ratings – refer to table on [page 13](#).

COLLAR



Construct a FyreBOARD Maxilite® wall collar, on one side of the penetration, by fixing 30mm thick x 100mm wide FyreBOARD Maxilite® strips around the three exposed sides of the FyreBOX. Fix FyreBOARD Maxilite® with 10g x 60mm plasterboard screws at 150mm centres and make certain that FyreBOARD Maxilite® is fixed flush with the wall opening (Trafalgar Fire strongly recommends this step is undertaken by a Trafalgar approved FyreBOX Certification Partner).

FINISHING

Complete the installation by following the Stages 3-4 steps outlined on [pages 28-29](#)

Click to Watch Installation Video



INSTALLATION STAGE 2: WALL INSTALLATION

ALPHA PANEL

CLOSE



Retrieve the bottom section of the FyreBOX and fit around the services, to the secured top section, confirming that all fixing tabs are properly locked into place.

FRAME



Install the wall's stud framing around the perimeter of the FyreBOX and fix the plasterboard as per the wall manufacturer's instruction, ensuring the annular gaps between the FyreBOX and wall openings are within 5-20mm and allow for deflection as required.

Framing only required for AlphaPanel walls that are sheeted with plasterboard on one or both sides, however even walls with just AlphaPanel require plasterboard lining, refer to the drawings at the end of the manual for specifics.

PLASTER



The opening is lined with FR plasterboard to assist with the performance of the FyreBOX Slab Mount system. Some Alpha Panel Walls need to be thickened with Maxilite. Depending on applications and FRL required, refer to the approvals on [page 12](#) (60 mins) and [page 16](#) (90mins).

FINISHING

Complete the installation by following the Stages 3-4 steps outlined on [pages 28-29](#)

Click to Watch Installation Video



INSTALLATION STAGE 2: WALL INSTALLATION

SPEEDPANEL®

ANGLES



Install the Speedpanel® C-Channel to the full perimeter of the FyreBOX ensuring the annular gaps between the FyreBOX and wall opening are within 5-20mm.

Install FR plasterboard to one side of the wall as per Speedpanel® installation specifications.

PANEL



Install the Speedpanel® wall panel as per the supplier's instructions, ensuring the annular gaps between the FyreBOX and wall opening are within 5-20mm.

COLLAR



For Speedpanel® walls less than 78mm construct a FyreBOARD Maxilite® wall collar, on one side of the penetration, by fixing 30mm thick x 100mm wide FyreBOARD Maxilite® strips around the three exposed sides of the FyreBOX. Fix FyreBOARD Maxilite® with 10g x 60mm plasterboard screws at 150mm centres and make certain that FyreBOARD Maxilite® is fixed flush with the wall opening (Trafalgar Fire strongly recommends this step is undertaken by a Trafalgar Fire approved FyreBOX Certification Partner).

FINISHING

Complete the installation by following the Stages 3-4 steps outlined on [pages 28-29](#)

Click to Watch Installation Video



INSTALLATION STAGE 3: FOAM INSTALLATION

ALL WALLS

Confirm that the installation up to this point has been done in accordance with the requirements for each wall type to ensure compliance.

SEAL



Fill all annular gaps between the FyreBOX and wall opening with FyreFLEX® Sealant to a depth of 20mm and finish with a 30x30mm fillet on each side of the penetration.

FYREBOX FOAM

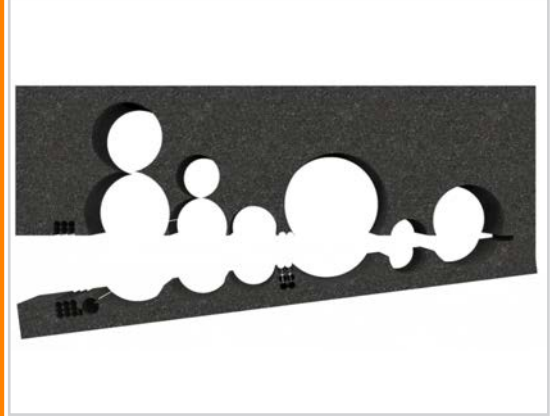

Retrieve the foam end plugs and cut a horizontal slit allowing you to open the foam. Cut out a rough profile of the services so that the foam can be fit snugly around them. Slide the foam over/around the services and into the FyreBOX

Please note: 30x30mm FyreFLEX® fillet is not needed if you are planning to use the 3 – sided TWRAP™ detail as shown on [page 29](#).

FOAM EXAMPLE



Plug any visible gaps in the end plugs with left over foam off cuts or FyreFLEX® Sealant. Note: It is recommended that after the foam is installed, a photograph should be taken for site records to demonstrate a compliant foam installation.

FILL FOAM GAPS



Click to Watch Installation Video



INSTALLATION STAGE 4: WRAPPING

ALL WALLS

If TWRAP™ is required for the services to achieve the insulation rating as described in the tables on pages 8-22, install as follows.

WRAP- SERVICES ONLY



In some instances, it is appropriate to For a 60 minutes insulation, simply wrap TWRAP™ around the required (or all services), ensuring each end overlaps by 50mm, and butt it up against the FyreBOX's foam end plugs. Secure the TWRAP™ in three locations with reinforced aluminium tape or stainless-steel cable ties around the entire circumference. Contact technical@tgroup.com.au to see if this is appropriate on your site.

WRAP UP TO 120MIN



For 90 or greater minutes insulation, simply wrap TWRAP™ around the services and FyreBOX casing, flaring the edges out against the underside of the slab. These edges should overlap the slab by at least 50mm and be held in place by 30x1x300mm flat steel tabs. Refer to install drawing below.

Some instances don't need any TWrap at all, check the FRL tables or contact technical@tgroup.com.au to confirm.

TWRAP - 3-Sided Wrap

Where the FyreBOX configuration does not achieve full insulation in a given fire barrier, TWRAP will need to be applied to the FyreBOX casing and services in order to increase their insulation rating up to -/XXX/120.

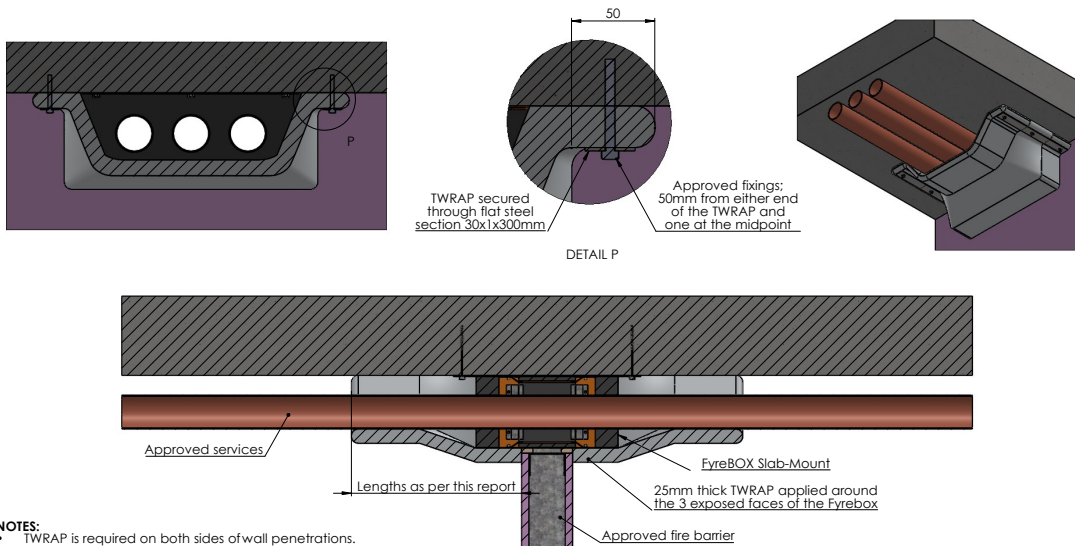

- NOTES:**
- TWRAP is required on both sides of wall penetrations.
 - Cable trays require infill material as-tested before wrapping

Click to Watch Installation Video



INSTALLATION ALTERNATIVES

RISER SHAFT

RISER SHAFT INSTALLATIONS

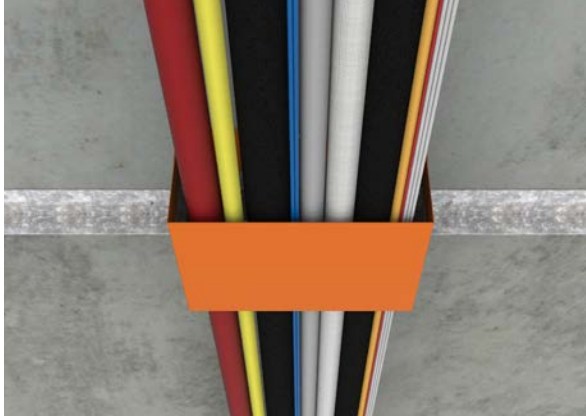

Where the FyreBOX cannot be centered in the wall due to narrow risers or slab edges being nearby.

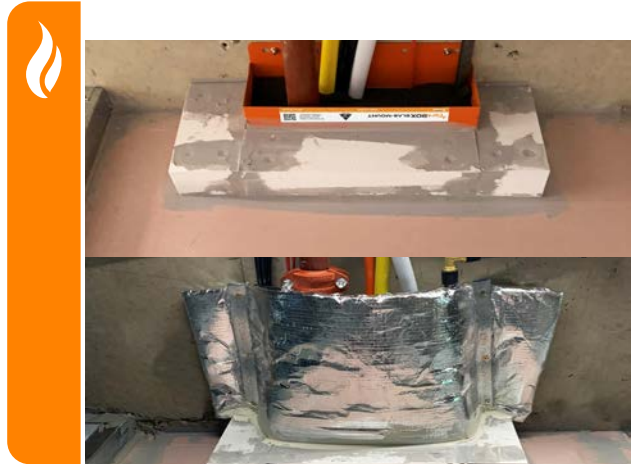

The FyreBOX can be installed offset to the wall using strips of FyreBOARD Maxilite® to locally thicken the penetration.

Riser Shaft Detail - FyreBOX™ Slab-Mount installed with access from one side

FyreBOX™ Slab-Mount to be installed, offset from the thickness of the fire barrier, as per the standard details for the corresponding barrier type

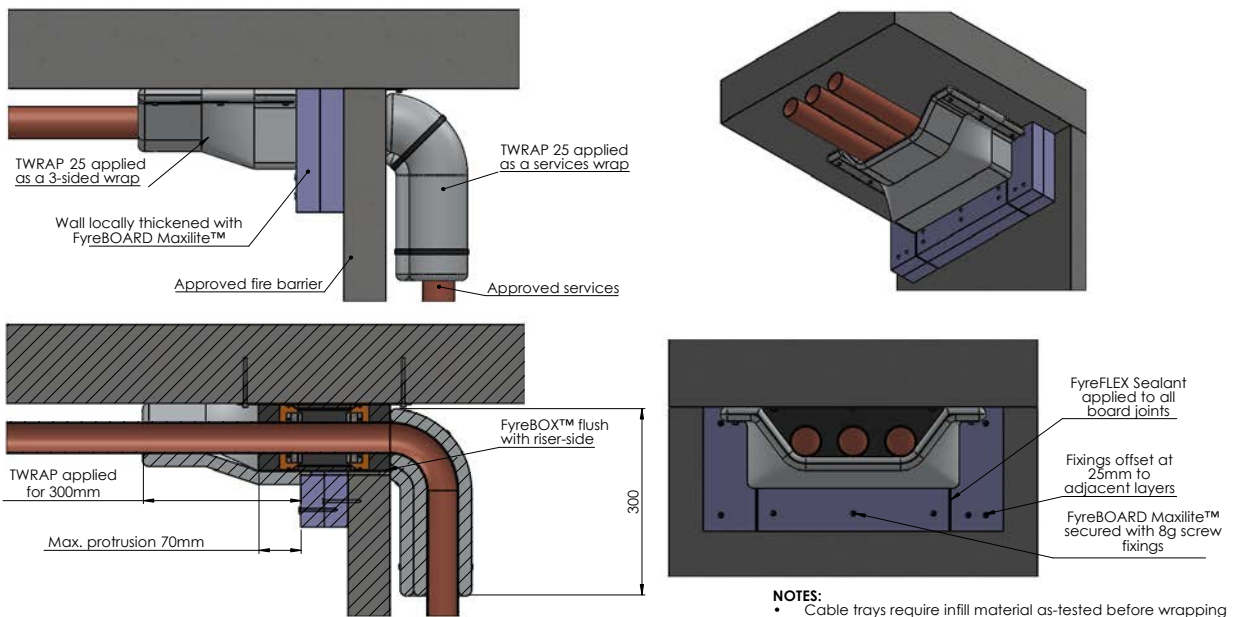

Click to Watch Installation Video



INSTALLATION ALTERNATIVES

STEPPED SLAB, WALL JUNCTIONS & OVERSIZED OPENINGS

Stepped Slabs

Where a step up in the slab is present, FyreBOARD Maxilite can be used to pack out the gap to the FyreBOX Slab-Mount. Suitable for steps up to 60mm, with min 100mm long fixings used to secure the FyreBOX Slab-Mount to the concrete through the Maxilite Board. [Refer to page 52 for Technical Drawing.](#)



Oversized Openings

For openings cut too large, up to 60mm FyreBOARD Maxilite can be used to pack out the opening and reduce the annular gap. This can also be done on the sides of the FyreBOX to reduce the width of the penetration. [Refer to page 53 for Technical Drawing.](#)

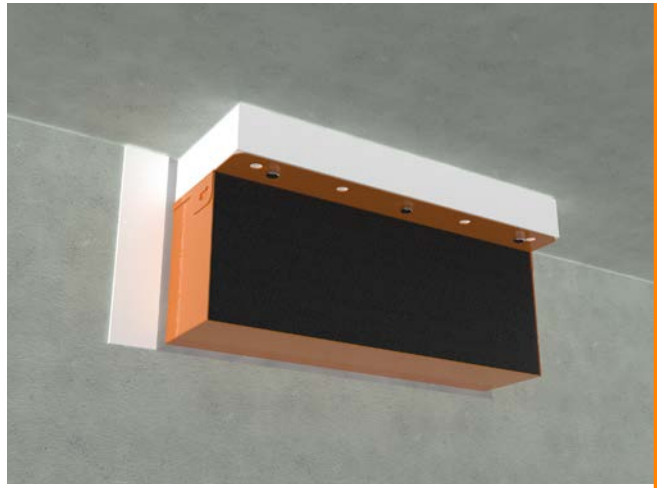

Wall Junctions

For FyreBOX Slab-Mount systems installed against adjacent barriers, FyreFLEX Sealant is applied to the perimeter (20mm depth) of the box so daylight cant be seen through, and TWrap can be installed 2-sided to the soffit and the wall. [Refer to page 54 for Technical Drawing.](#)



INSTALLATION ALTERNATIVES

FYREBOX DOUBLE VERTICAL

FYREBOX DOUBLE VERTICAL

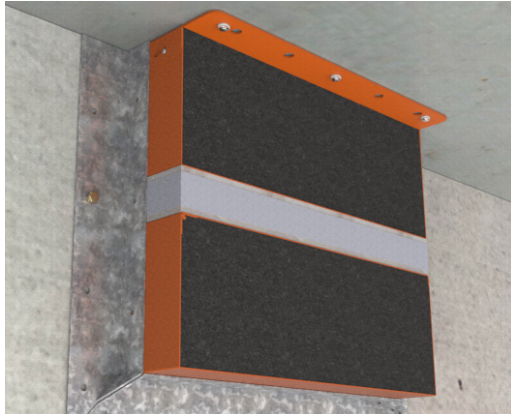

Where a large run of services needs firestopping in a small width of wall.

Stacked - Vertical

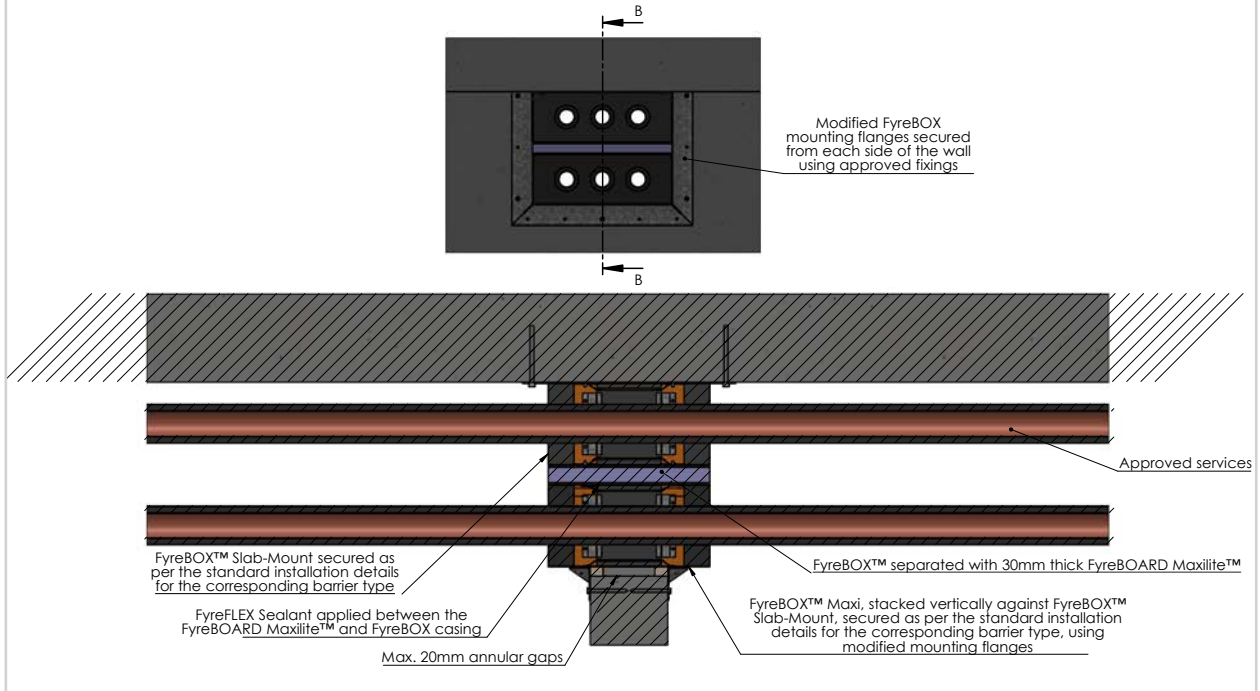

Click to Watch Installation Video



INSTALLATION ALTERNATIVES

FYREBOX DOUBLE HORIZONTAL

DOUBLE HORIZONTAL

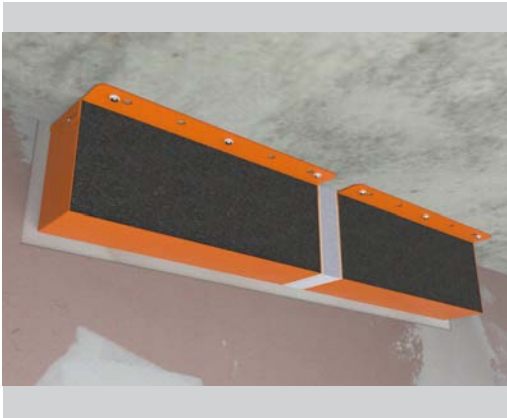

For where large amounts of services exit a riser shaft wall.



Double vertical FyreBOX installed above a doorway to allow for the provision of large amounts of services in a small space.

Stacked - Horizontal

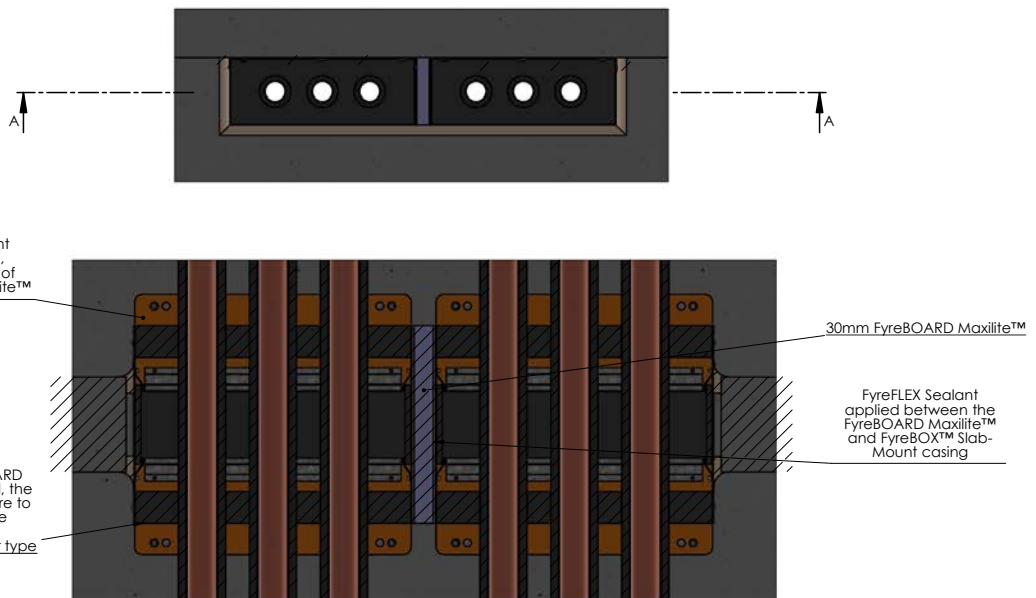

Click to Watch Installation Video



INSTALLATION ALTERNATIVES

INTRWALL / PARTY WALLS

If TWRAP™ is required for the services to achieve the insulation rating as described in the tables on pages 6-15, install as follows.

STANDARD FYREBOX INSTALL



FyreBOX top plate, body and approved services all installed as standard to the soffit, with foam end plugs installed around the services.

INSTALL WALL



Install the wall as per the manufacturer's instruction.

FINISH

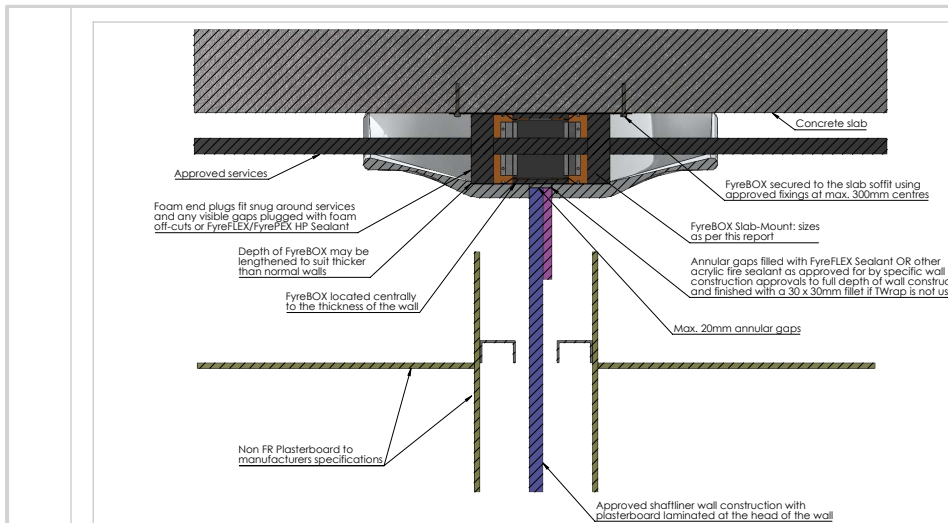

Drawing Name: Head of Party Wall Penetration		Test Standard: AS1530.4	Codes:	Revision:	Date:	No.:	NOTICE
Project Title: FyreBOX Slab-Mounted - Generic Install		Fire resistance level:	Drawn By: SM				
Drawing No.: 1	Sheet: 1 of 1	Date: 26/08/2022	Scale: NTS	Based on Report No.:	Checked By: JH	<input type="checkbox"/> STANDARD DRAWING <input checked="" type="checkbox"/> PROJECT DRAWING	

Click to Watch Installation Video



If the wall does not already require it, install a layer of FR plasterboard at the head of the wall.
Install the FyreFLEX Sealant to the full depth of the plasterboard & TWrap to the required length.

INSTALLATION CHECKLIST

PLASTERBOARD

FyreBOX Label/Identifier No. _____

Installer Name: _____

Company: _____

Site: _____

Floor/Level: _____ FRL _____

Installation Checklist		Satisfactory	Action Required
1	Is the FyreBOX located centrally to the thickness of the wall?		
2	Are correct fixings (M6 masonry Anchors, 4mm gas or powder actuated anchors, or any other steel anchor of equal pull out rating) used to fix the top side of FyreBOX onto the floor slab?		
3	Are there 2 fixings per side, or maximum gap between the anchors at 300mm?		
4	Does the size of the wall opening allow for annular gap between the opening and FyreBOX within 5 to 20 mm?		
5	Are the services running through the FyreBOX as per the approved services list on the technical manual?		
6	Is the stud framing around the perimeter of the box installed as per the wall manufacturer's instructions?		
7	Is the sealant applied to correct depth of 20 mm on each side with a (fillet size of approximately 30x30mm) Note: If 3-sided wrap is used, fillet not required		
8	Is the foam snugly fit around the services and any visible gaps covered with foam off-cuts or FyreFLEX® sealant?		
Services only wrap (if applicable)			
1	Does the TWRAP™ wrap around the services and overlaps itself by 50mm?		
2	Is the TWRAP™ butted against the FyreBOX foam and end plugs?		
3	Is the TWRAP™ secured in three locations with reinforced aluminium tape or stainless-steel cable ties around the entire circumference?		
3-sided wrap (if applicable)			
1	Does the TWRAP™ cover the services including the FyreBOX and flaring at least 50mm at edges and against the slab?		
2	Is the correct steel tab (30x1x300mm) used to hold the TWRAP™ in place on both sides of the FyreBOX?		
3	Are correct fixings M6 masonry Anchors used to fix the steel tab and TWRAP™ onto the floor slab, 3x per side?		
4	Is the TWRAP™ butted up against the wall, around the box?		

For a full list of installation instructions, refer to the installation [pages 23-34](#) of this FyreBOX Slab-Mount Technical Manual.

INSTALLATION CHECKLIST

AAC PANEL WALL

FyreBOX Label/Identifier No. _____

Installer Name: _____

Company: _____

Site: _____

Floor/Level: _____ FRL _____

Installation Checklist		Satisfactory	Action Required
1	Is the FyreBOX located centrally to the thickness of the wall?		
2	Are correct fixings (M6 masonry Anchors, 4mm gas or powder actuated anchors, or any other steel anchor of equal pull out rating) used to fix the top side of FyreBOX onto the Floor slab?		
3	Are there 2 fixings per side, or maximum gap between the anchors at 300mm?		
4	Does the size of the wall opening allow for annular gap between the opening and FyreBOX within 5 to 20 mm?		
5	Are the services running through the FyreBOX as per the approved services list on the technical manual?		
6	Are the Hebel® wall's head track angles installed as per the wall manufacturer's instructions on both sides?		
7	Is the sealant applied to correct depth of 20 mm on each side with a (fillet size of approximately 30x30mm) Note: If 3-sided wrap is used, fillet not required		
8	Is the foam snugly fit around the services and any visible gaps covered with foam off-cuts or FyreFLEX® sealant?		
Services only wrap (if applicable)			
1	Is the FyreBOARD Maxilite® wall collar constructed correctly? (One side of the penetration using three 30mm thick x 100 mm FyreBOARD Maxilite® strips) *(FyreBOARD Maxilite® collar not needed if planning to use 3-sided TWRAP™)		
2	Are the boards fixed using 10gx60mm plasterboard screws at 150mm centres and flush with the wall opening?		
3	Is the resulting gap sealed with FyreFLEX® Sealant (full depth and fillet size of 30x30mm)?		
4	Does the TWRAP™ wrap around the services and overlaps itself by 50mm? (TWRAP™ only needs to be applied on conductive services)		
5	Is the TWRAP™ butted against the FyreBOX foam and end plugs?		
6	Is the TWRAP™ secured in three locations with reinforced aluminium tape or stainless-steel cable ties around the entire circumference?		
3-sided wrap (if applicable)			
1	Does the TWRAP™ cover the services including the FyreBOX and flaring at least 50mm at edges and against the slab?		
2	Is the correct steel tab (30x1x300mm) used to hold the TWRAP™ in place on both sides of the FyreBOX?		
3	Are correct fixings M6 masonry Anchors used to fix the steel tab and TWRAP™ onto the Floor slab, 3x per side?		
4	Is the TWRAP™ butted up against the wall, around the box?		

For a full list of installation instructions, refer to the installation [pages 23-34](#) of this FyreBOX Slab-Mount Technical Manual.

SYSTEM RANGE



FyreBOX SLAB-MOUNT



Item Number	Description	Dimensions
FYREBOX-SM-BAMBINO	160 x 125 x 250mm	
FYREBOX-SM-350	350 x 125 x 250mm	
FYREBOX-SM-550	550 x 125 x 250mm	
FYREBOX-SM-650	650 x 125 x 250mm	
FYREBOX-SM-Custom	Any size from 100 up to 1250 x 125 x 250mm	

SYSTEM COMPONENTS



Item Number	Description	Min Order Qty
TWRAP- 300 x 810mm	300 x 810 x 25mm Pre Cut Strip	1
TWRAP- 300 x 1010mm	300 x 1010 x 25mm Pre Cut Strip	1
TWRAP Roll- 300mm	300 x 7620 x 25mm Full Roll	1
Maxilite Strips FYREBOX SM 350	1 Strip at 580 x 100 x 30mm 2 Strips at 145 x 100 x 30mm	-

COMPLIANCE



COMPLIANCE WITH THE NATIONAL CONSTRUCTION CODE (NCC)

Formerly known as BCA

Under the NCC requirements, a multiple service transit system for service penetrations should be fire tested in every configuration that it is intended for use in, both completely empty (blank seal), partially full and completely full of services so that the product may be installed with as many or as little services as required on site. It is important to fire test in all the different walls types and with different configurations, quantities and types of services which is a time consuming (and expensive) exercise.

Trafalgar Fire FyreBOX systems have been fire tested extensively to AS1530.4-2014 and approved in accordance with Section 4 AS4072.1 as required by Schedule 5 of the NCC. This includes over 200 hours of accredited furnace time and 30 plus individual test reports to cover the full range of service and wall configurations that allow us to comfortably stand behind our multiple SYSTEM approvals.

These configurations include but are not limited to:

- Service fill ratio: Empty (blank seal), half full and completely full of services
- Barrier types: Various types of plasterboard, concrete, Blockwork, Hebel®, Walsc®, Speedpanel®, Pronto panel, FyreBOARD Maxilite®, concrete floors, plasterboard ceilings, corex walls etc
- Services: Bare and insulated metal pipes, cable trays and cable bundles, aluminium cables, PVC pipes & conduits, PEX and PEX-AL-PEX pipes, cPVC pipes etc
- Configurations: Blank seal (empty), full of services, double stacked, side by side etc
- Insulation performance: Tested both wrapped and unwrapped with TWRAP™ to ensure the system works in both configurations
- Penetration sizes: 150 x 125, 350x125, 550x125, 1100x125
- FyreBOX Variants: Slab-Mount, Slab-Mount Bambino, Cast-in, Maxi & Mini (retrofit)

When choosing a multiple service transit penetration system like FyreBOX, it is important to check that all aspects of your system have been fire tested and are fit for purpose.

Compliance will only be achieved when the installation on site mirrors the tested system.

TEST AND ASSESSMENT REPORTS

The above-mentioned fire testing reports have all been conveniently summarised into **BRANZ assessment report FC10266 (available on www.tfire.com.au)** which neatly tabulates the approved services in a range of fire barriers, for all FyreBOX variants and applications, and covers only minor variations to the tested systems, thereby providing trouble free certification according to NCC.

Importantly, every aspect of the assessment report are backed up by the fire test data and the individual fire test reports are available on request for certification purposes.

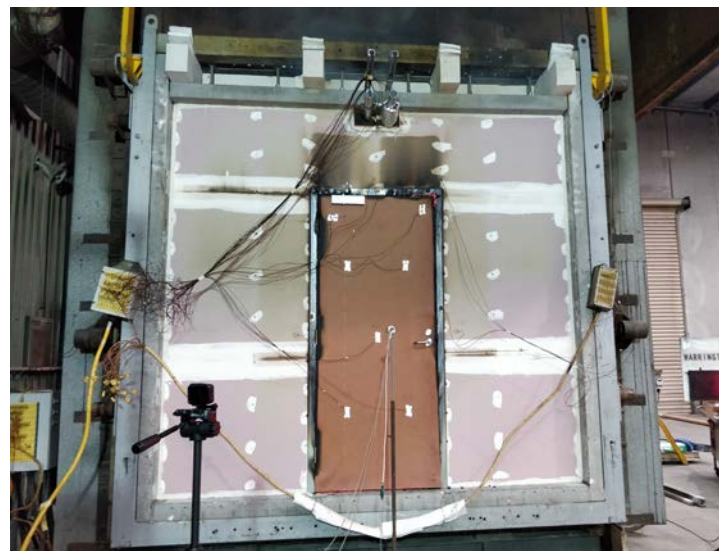

FyreBOX Slab-Mount - Installation Overview

STEP 1

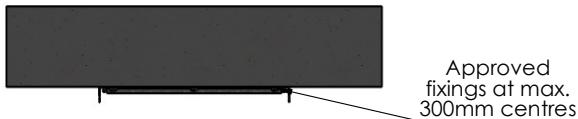

Secure top-section of FyreBOX to slab soffit, ensuring it will be located centrally to the thickness of the wall

STEP 2

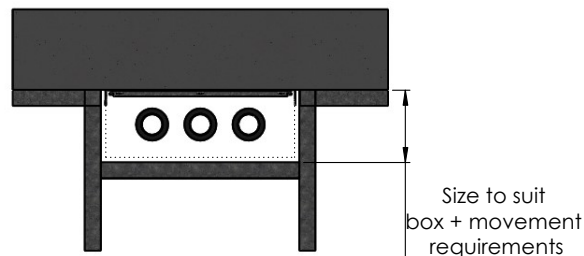

Run approved services through the FyreBOX, ensuring they will be located within the completed FyreBOX opening.

NOTE: Services can be run at any stage of the install

STEP 3

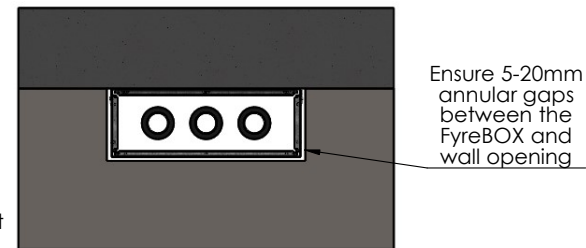

Clip together the bottom-section of the FyreBOX and construct the approved fire wall

NOTE: The FyreBOX Slab-Mount can also be retrofit into existing wall systems

STEP 4

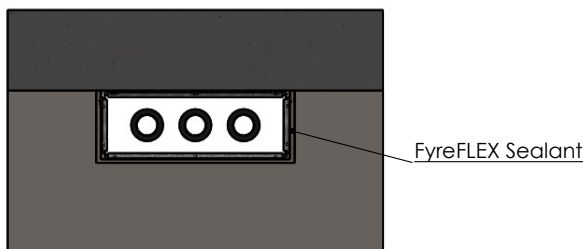

Fill annular gaps with FyreFLEX Sealant to a depth of at least 20mm, from each side of the wall

STEP 5



Retrieve foam end plugs and form openings to match the services within the FyreBOX. Cutting a slit through these openings will allow for the plug to be opened and inserted around the existing services

STEP 6

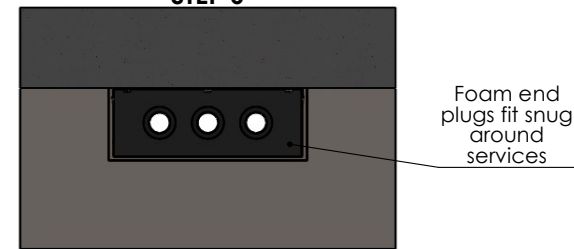

Fit foam end plugs tightly around the services, from each side of the FyreBOX, and plug any gaps with foam off cuts or FyreFLEX/FyrePEX HP Sealant. Continue to TWRAP drawings if wrapping will be required for full insulation.

NOTE: This is a generic installation guide. For specific details relevant to each barrier type, please refer to the corresponding installation drawing.

Drawing Name: Installation Overview

Test Standard:
AS1530.4

Codes:

Revision:

Date:

No.:

NOTICE:

Project Title: FyreBOX Slab-Mount - Generic Install

Fire resistance level:

Drawn By:
JC

NOTE: ALL DIMENSIONS ARE IN MILLIMETRES (mm)

Drawing No. :
2

Sheet:
2 of 19

Date:
27/05/2020

Scale:
NTS

Based on Report No.:

Checked By:
CT

STANDARD DRAWING
 PROJECT DRAWING



Plasterboard framing details

Option A - Full-width nogging between studs
Recommended for areas above fire doors

Option B - Head track contoured around opening
Recommended for penetrations remote from fire doors

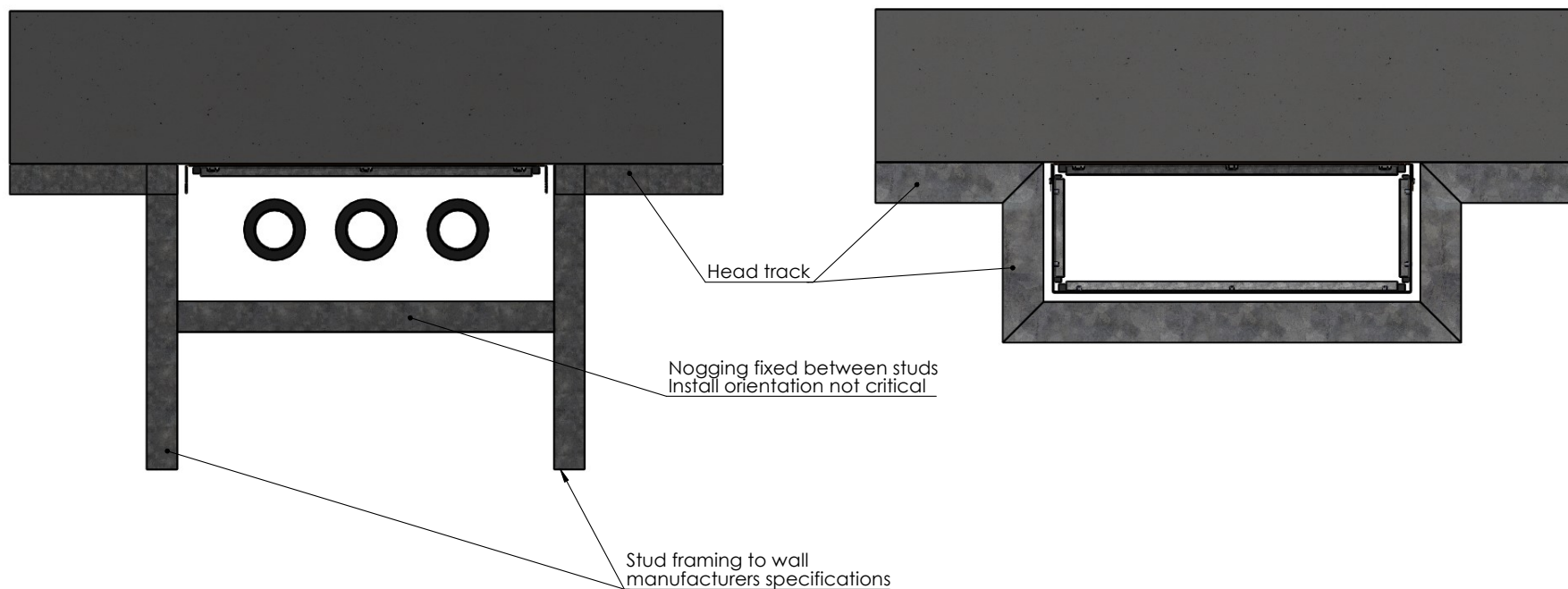

Notes:

- Both options are as-tested
- Both options have been tested without the opening being lined with plasterboard
- When located above fire doors, option A is the recommended installation detail
- Openings are to allow sufficient clearance for building movement

Drawing Name: Plaster framing details				Test Standard: AS1530.4	Codes:	Revision:	Date:	No.:	NOTICE:
Project Title: FyreBOX Slab-Mount - Generic Install				Fire resistance level:	Drawn By: JC				<small>NOTE: ALL DIMENSIONS ARE IN MILLIMETRES (mm)</small>
Drawing No. : 3	Sheet: 3 of 19	Date: 27/05/2020	Scale: NTS	Based on Report No.:	Checked By: CT	<input type="checkbox"/> STANDARD DRAWING <input type="checkbox"/> PROJECT DRAWING			

Standard Plasterboard Walls

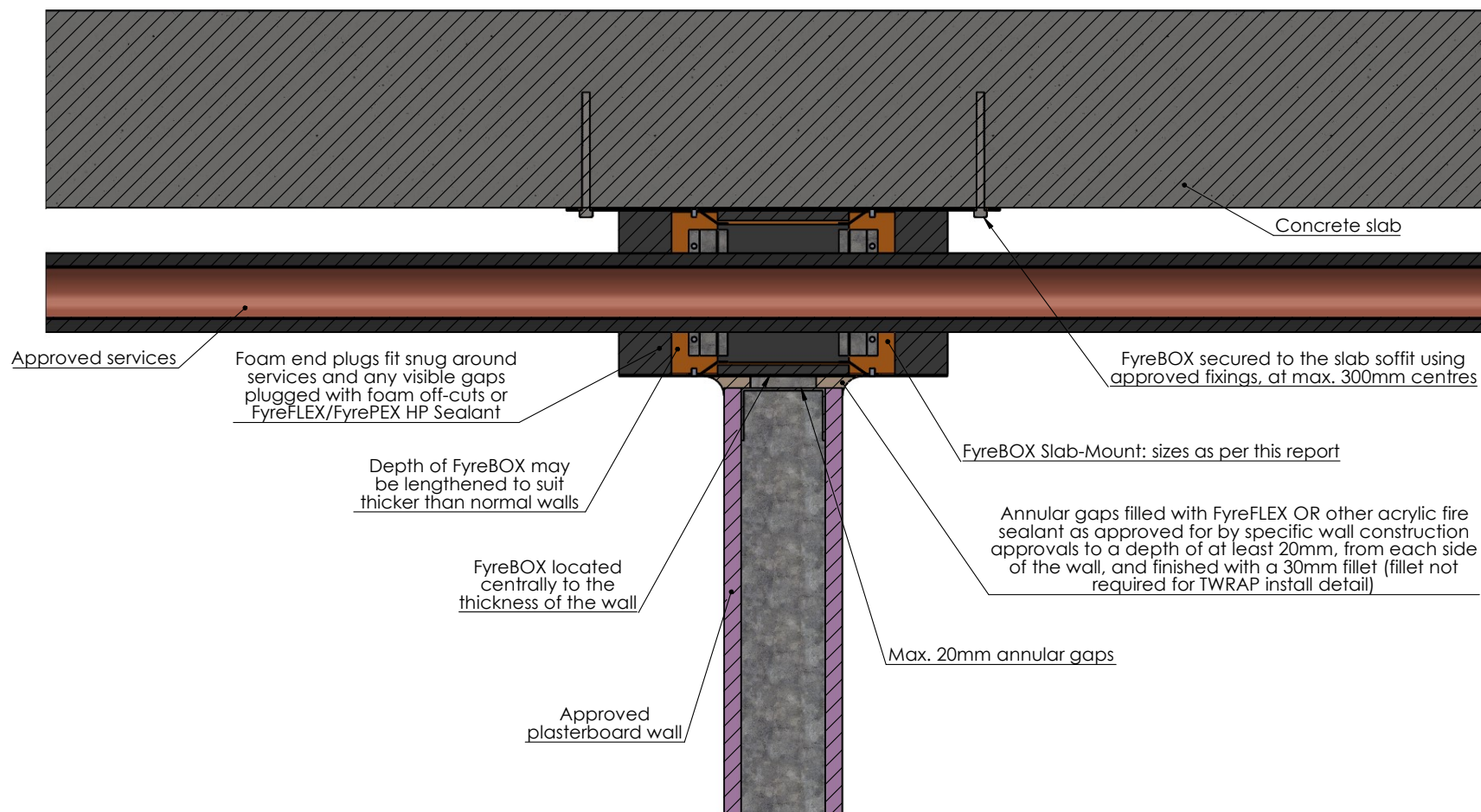

Drawing Name: Standard Plasterboard				Test Standard: AS1530.4	Codes:	Revision:	Date:	No.:	NOTICE:
Project Title: FyreBOX Slab-Mount - Generic Install				Fire resistance level:	Drawn By: JC	<small>NOTE: ALL DIMENSIONS ARE IN MILLIMETRES (mm)</small>			
Drawing No. : 4	Sheet: 4 of 19	Date: 27/05/2020	Scale: NTS	Based on Report No.:	Checked By: CT	<input type="checkbox"/> STANDARD DRAWING <input type="checkbox"/> PROJECT DRAWING			

ShaftLiner Walls

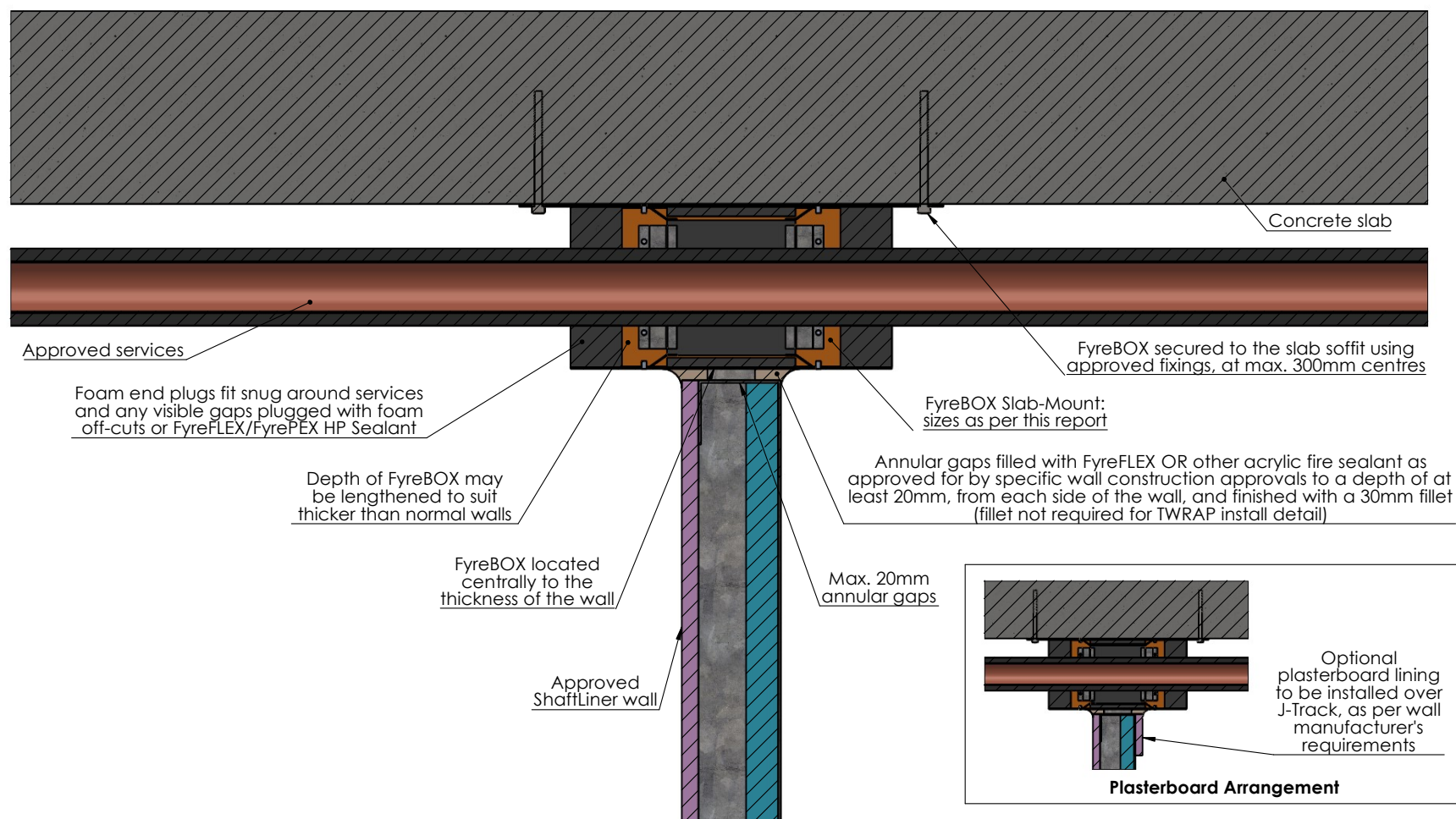

Drawing Name: ShaftLiner				Test Standard: AS1530.4	Codes:	Revision:	Date:	No.:	NOTICE:
Project Title: FyreBOX Slab-Mount - Generic Install				Fire resistance level:	Drawn By: JC				<small>NOTE: ALL DIMENSIONS ARE IN MILLIMETRES (mm)</small>
Drawing No. : 6	Sheet: 6 of 19	Date: 27/05/2020	Scale: NTS	Based on Report No.:	Checked By: CT	<input type="checkbox"/> STANDARD DRAWING <input type="checkbox"/> PROJECT DRAWING			

Hebel/Walsc AAC Walls - Openings up to 400x170mm

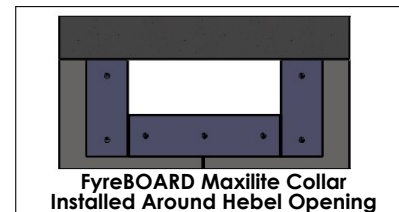
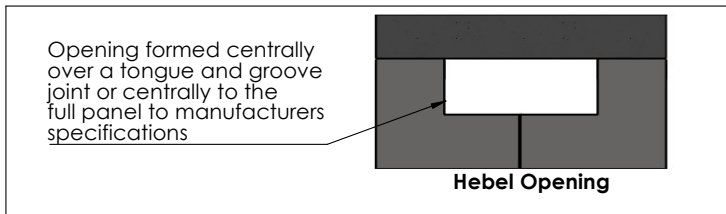
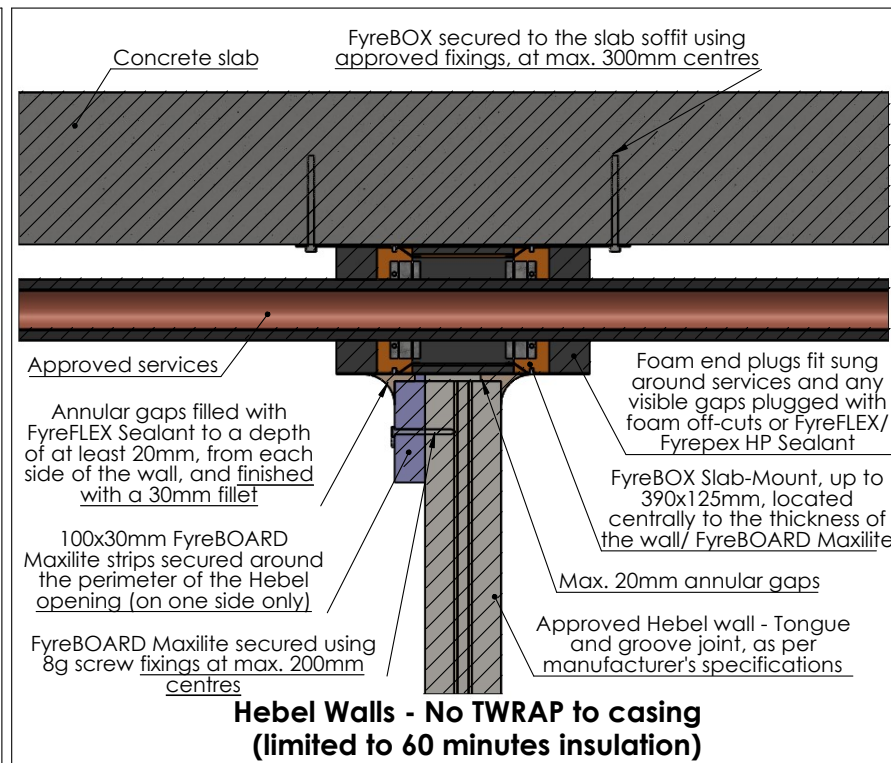
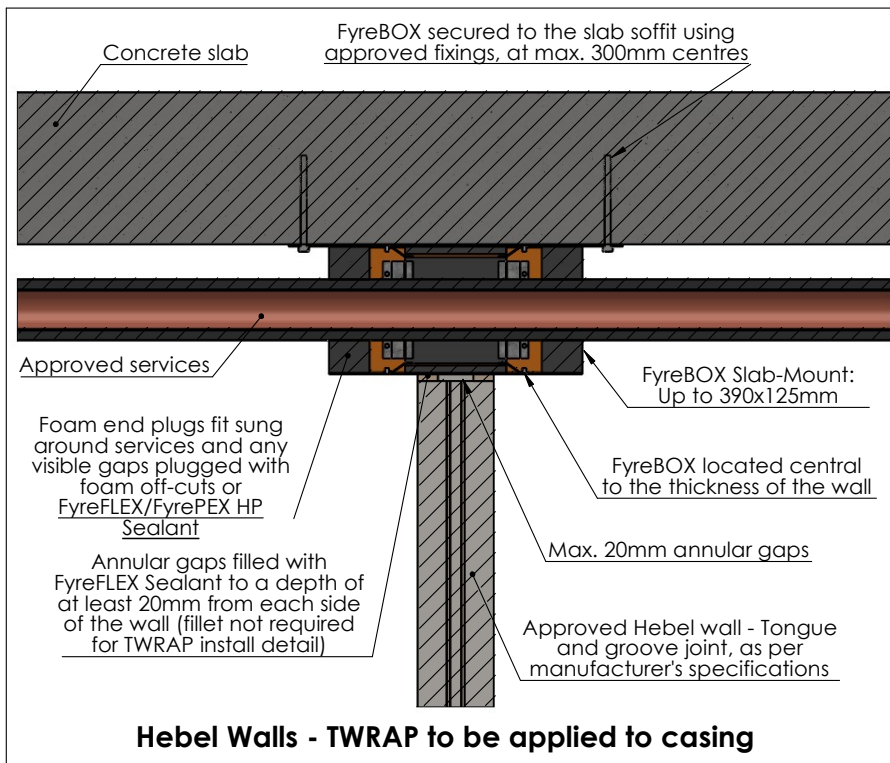

Drawing Name: Hebel/Walsc - Small Openings				Test Standard: AS1530.4	Codes:	Revision:	Date:	No.:	NOTICE:
Project Title: FyreBOX Slab-Mount - Generic Install				Fire resistance level:	Drawn By: JC				NOTE: ALL DIMENSIONS ARE IN MILLIMETRES (mm)
Drawing No.: 7	Sheet: 7 of 19	Date: 27/05/2020	Scale: NTS	Based on Report No.:	Checked By: CT	<input type="checkbox"/> STANDARD DRAWING <input type="checkbox"/> PROJECT DRAWING			

Hebel/Walsc AAC Walls - Openings greater than 400x170mm

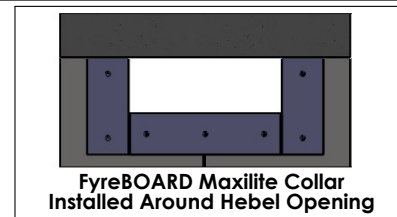
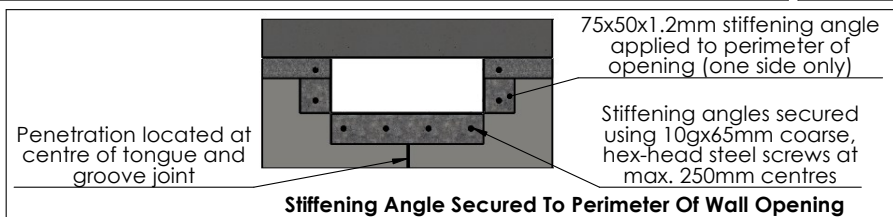
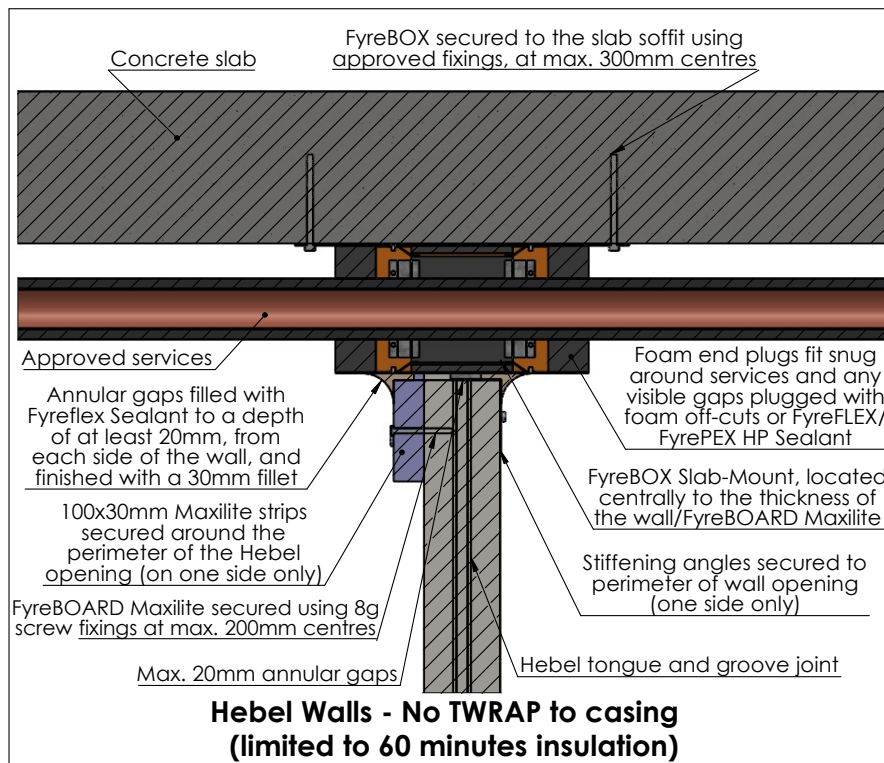
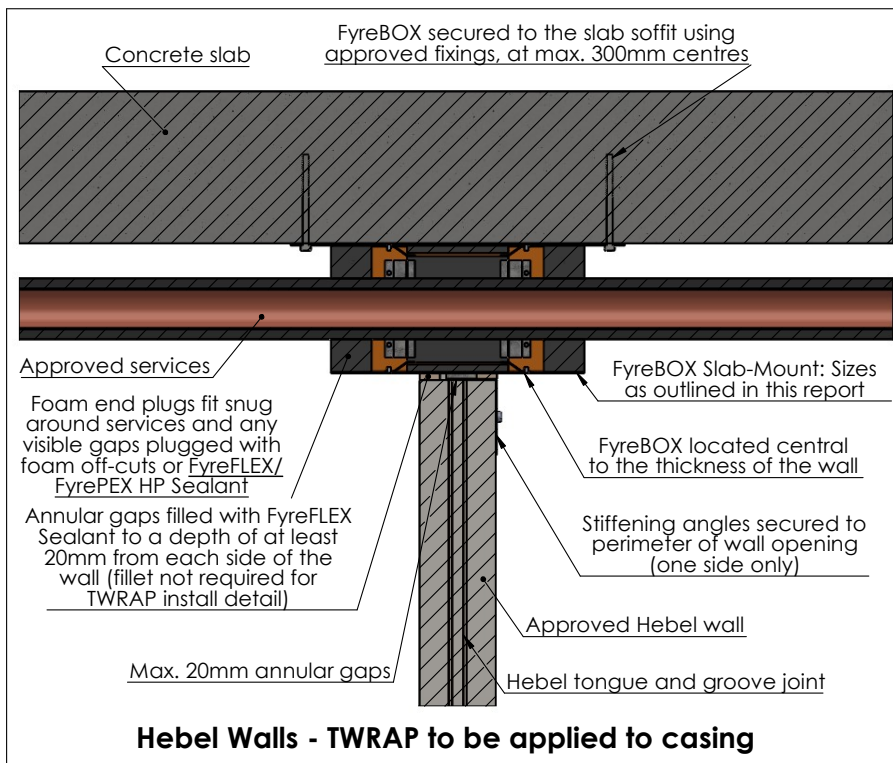

Drawing Name: Hebel/Walsc - Large Openings				Test Standard: AS1530.4	Codes:	Revision:	Date:	No.:	NOTICE:
Project Title: FyreBOX Slab-Mount - Generic Install				Fire resistance level:	Drawn By: JC	NOTE: ALL DIMENSIONS ARE IN MILLIMETRES (mm)			
Drawing No. : 8	Sheet: 8 of 19	Date: 27/05/2020	Scale: NTS	Based on Report No.:	Checked By: CT				



Click here to go back to Contents

SpeedPanel Walls

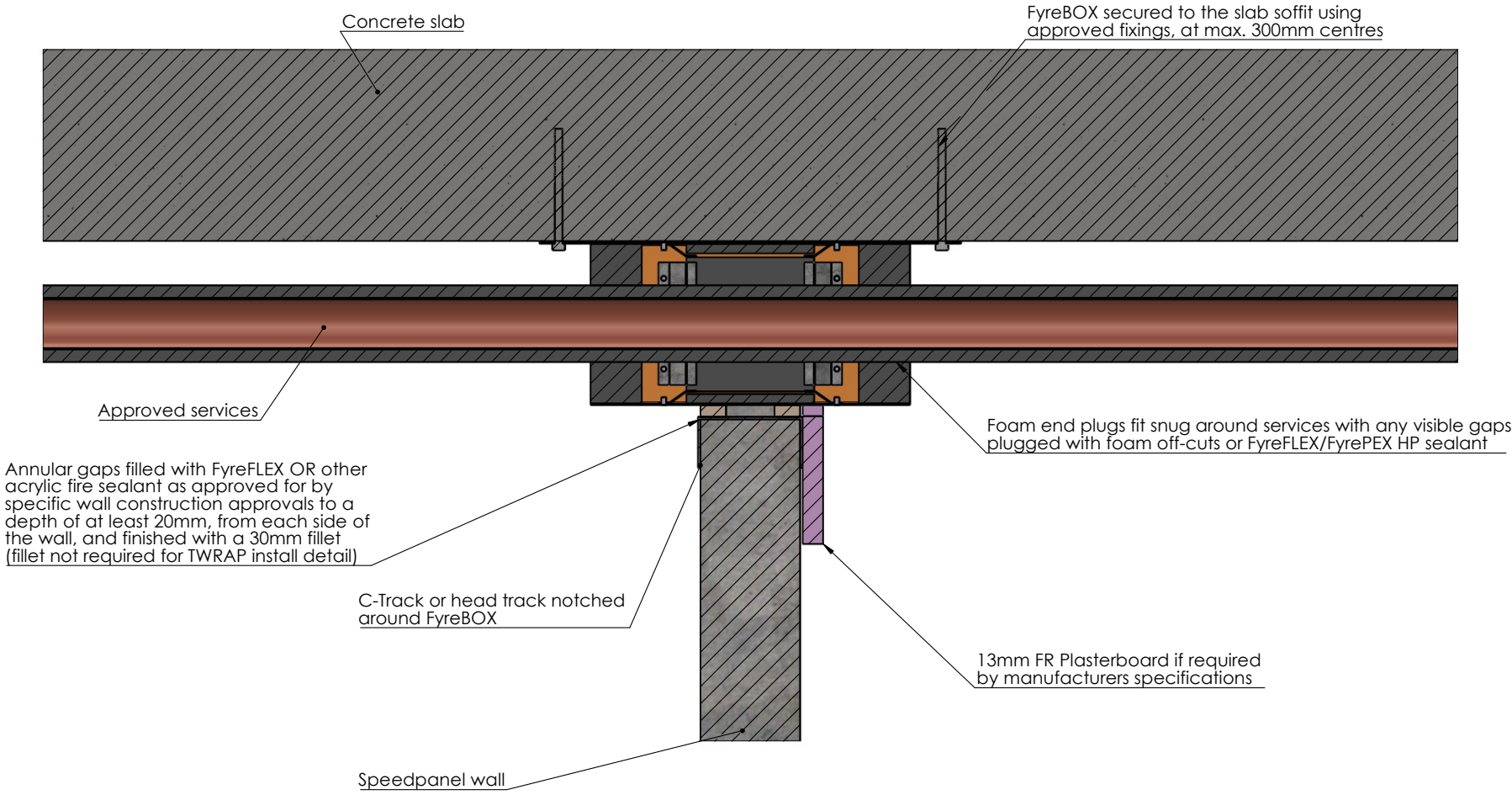

Drawing Name: SpeedPanel				Test Standard: AS1530.4	Codes:	Revision:	Date:	No.:	NOTICE:
Project Title: FyreBOX Slab-Mount - Generic Install				Fire resistance level: SECTION T-T SCALE 1 : 3	Drawn By: JC	<small>NOTE: ALL DIMENSIONS ARE IN MILLIMETRES (mm)</small>			
Drawing No. : 10	Sheet: 10 of 19	Date: 27/05/2020	Scale: NTS	Based on Report No.:	Checked By: CT				



Concrete / Masonry Walls (with or without permanent formwork)

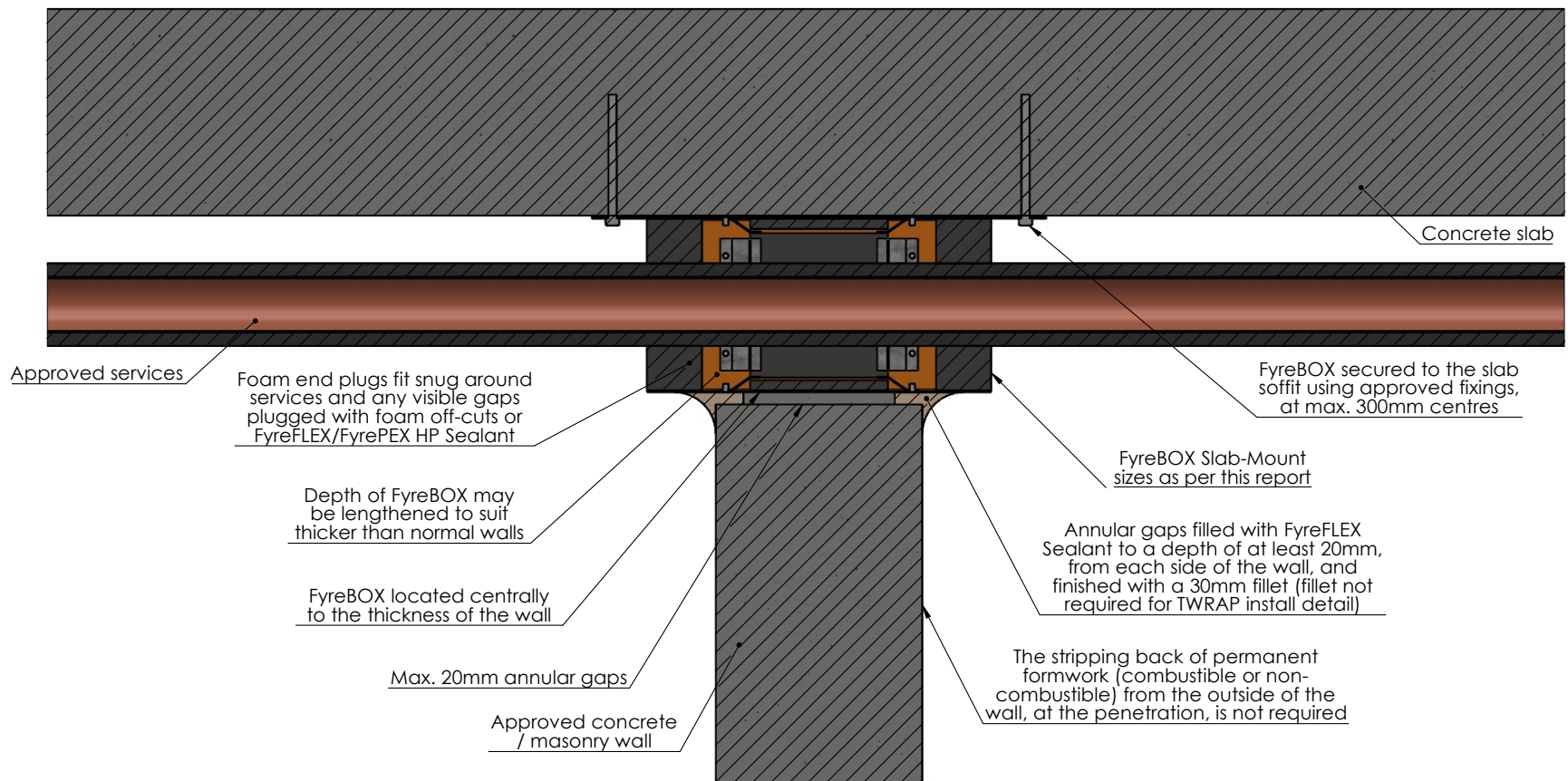

Drawing Name: Concrete / Masonry				Test Standard: AS1530.4	Codes:	Revision:	Date:	No.:	NOTICE:
Project Title: FyreBOX Slab-Mount - Generic Install				Fire resistance level:	Drawn By: JC				<small>NOTE: ALL DIMENSIONS ARE IN MILLIMETRES (mm)</small>
Drawing No. : 11	Sheet: 11 of 19	Date: 27/05/2020	Scale: NTS	Based on Report No.:	Checked By: CT	<input type="checkbox"/> STANDARD DRAWING <input type="checkbox"/> PROJECT DRAWING			

Click here to go back to Contents

FyreBOARD Maxilite

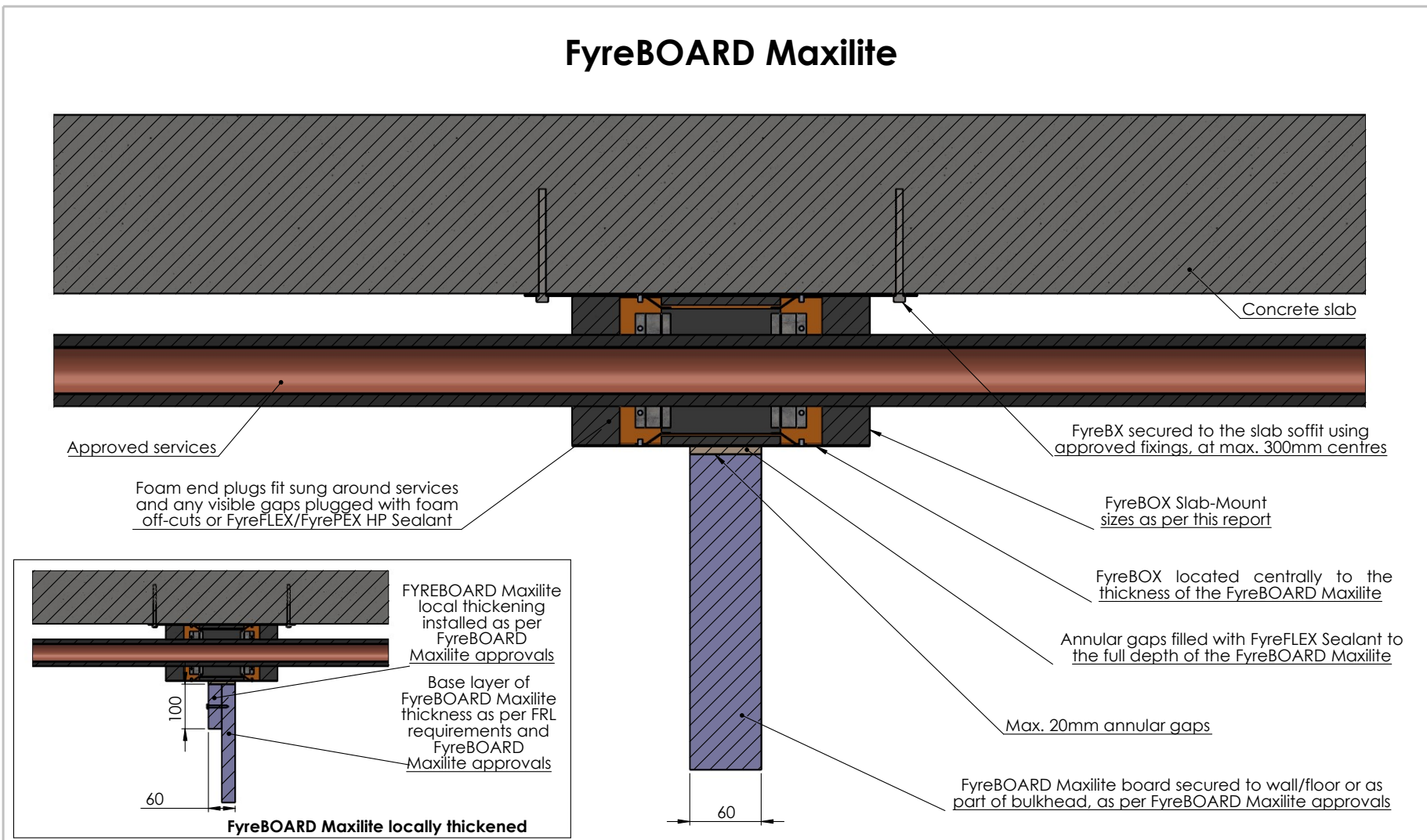

Drawing Name: FyreBOARD Maxilite				Test Standard: AS1530.4	Codes:	Revision:	Date:	No.:	NOTICE:
Project Title: FyreBOX Slab-Mount - Generic Install				Fire resistance level:	Drawn By: JC	NOTE: ALL DIMENSIONS ARE IN MILLIMETRES (mm)			
Drawing No. : 12	Sheet: 12 of 19	Date: 27/05/2020	Scale: NTS	Based on Report No.:	Checked By: CT				



TWRAP - Services Wrap

Where the FyreBOX configuration doesn't achieve full insulation in a given fire barrier, TWRAP can be applied to individual or groups of services in order to increase their insulation rating up to -/XXX/120, as required.

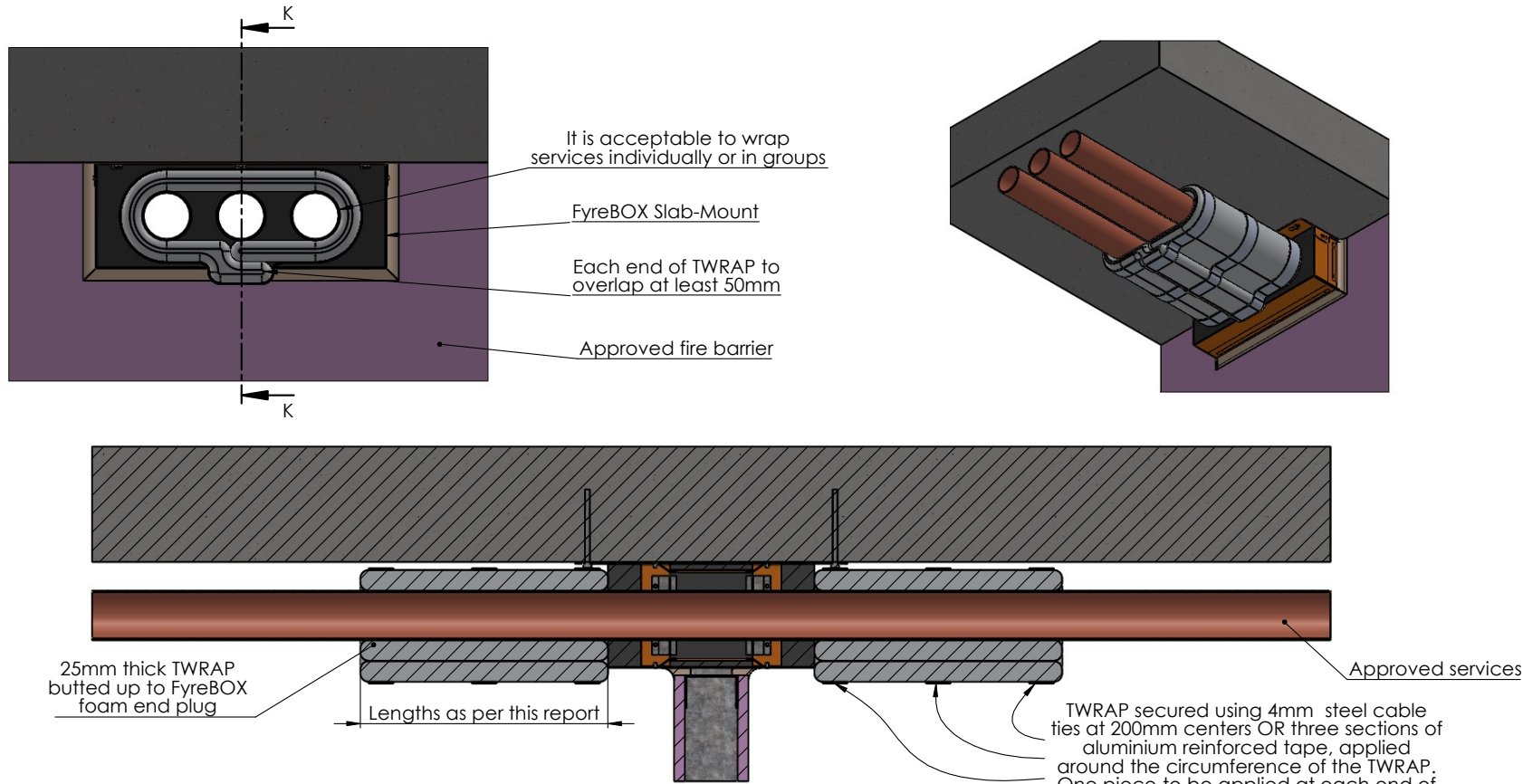

- NOTES:**
- TWRAP is required on both sides of wall penetrations.
 - Cable trays require infill material as-tested before wrapping

Drawing Name: TWRAP - Services Wrap				Test Standard: AS1530.4	Codes:	Revision:	Date:	No.:	NOTICE:
Project Title: FyreBOX Slab-Mount - Generic Install				Fire resistance level:	Drawn By: JC	NOTE: ALL DIMENSIONS ARE IN MILLIMETRES (mm)			
Drawing No. : 13	Sheet: 13 of 19	Date: 27/05/2020	Scale: NTS	Based on Report No.:	Checked By: CT				



TWRAP - 3-Sided Wrap

Where the FyreBOX configuration does not achieve full insulation in a given fire barrier, TWRAP will need to be applied to the FyreBOX casing and services in order to increase their insulation rating up to -/XXX/120.

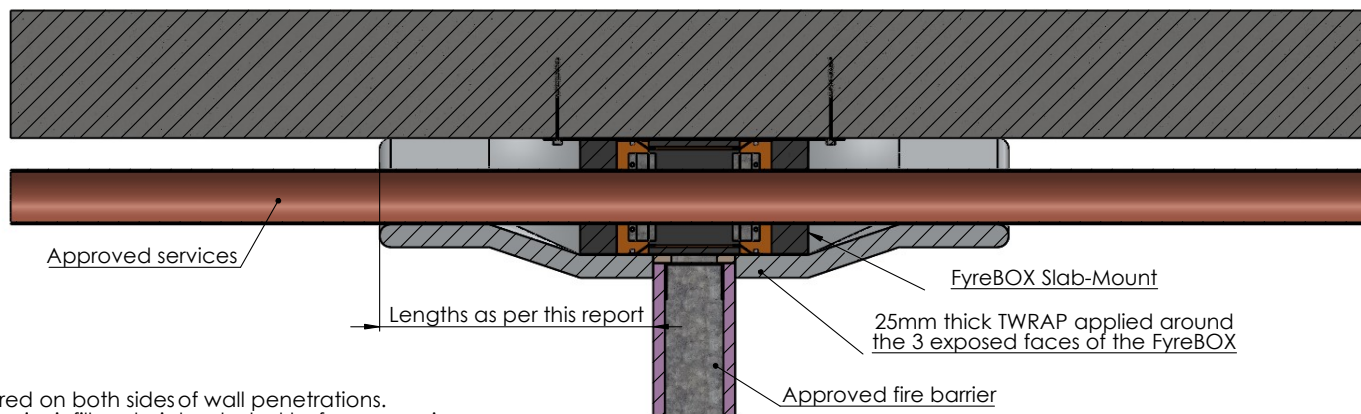
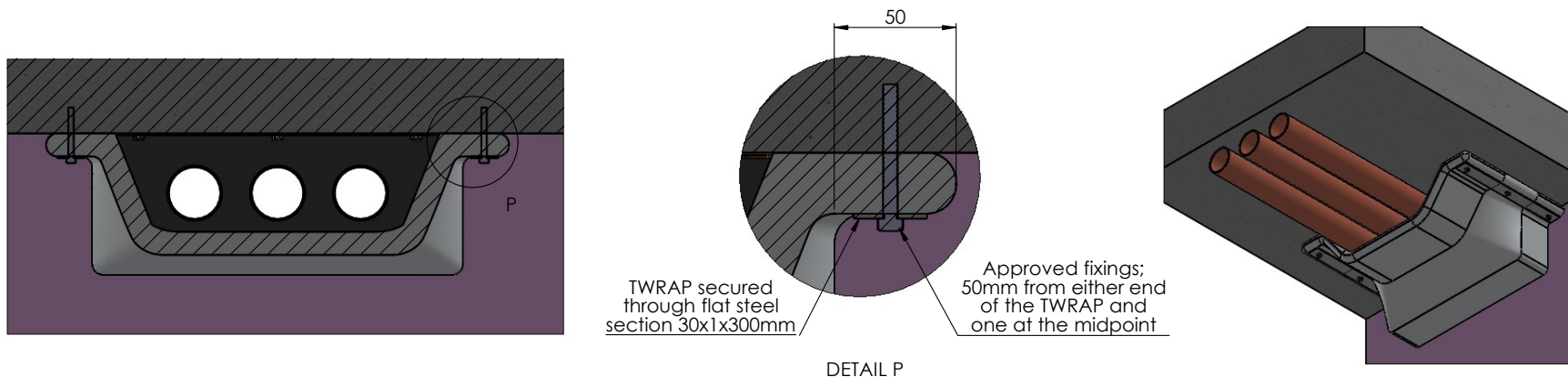

- NOTES:**
- TWRAP is required on both sides of wall penetrations.
 - Cable trays require infill material as-tested before wrapping

Drawing Name: TWRAP - 3-Sided Wrap				Test Standard: AS1530.4	Codes:	Revision:	Date:	No.:	NOTICE:
Project Title: FyreBOX Slab-Mount - Generic Install				Fire resistance level:	Drawn By: JC				<small>NOTE: ALL DIMENSIONS ARE IN MILLIMETRES (mm)</small>
Drawing No. : 14	Sheet: 14 of 19	Date: 27/05/2020	Scale: NTS	Based on Report No.:	Checked By: CT	<input type="checkbox"/> STANDARD DRAWING <input type="checkbox"/> PROJECT DRAWING			

Click here to go back to Contents

TWRAP - Stacked (Vertical)

- TWRAP detail required on each side of wall penetrations

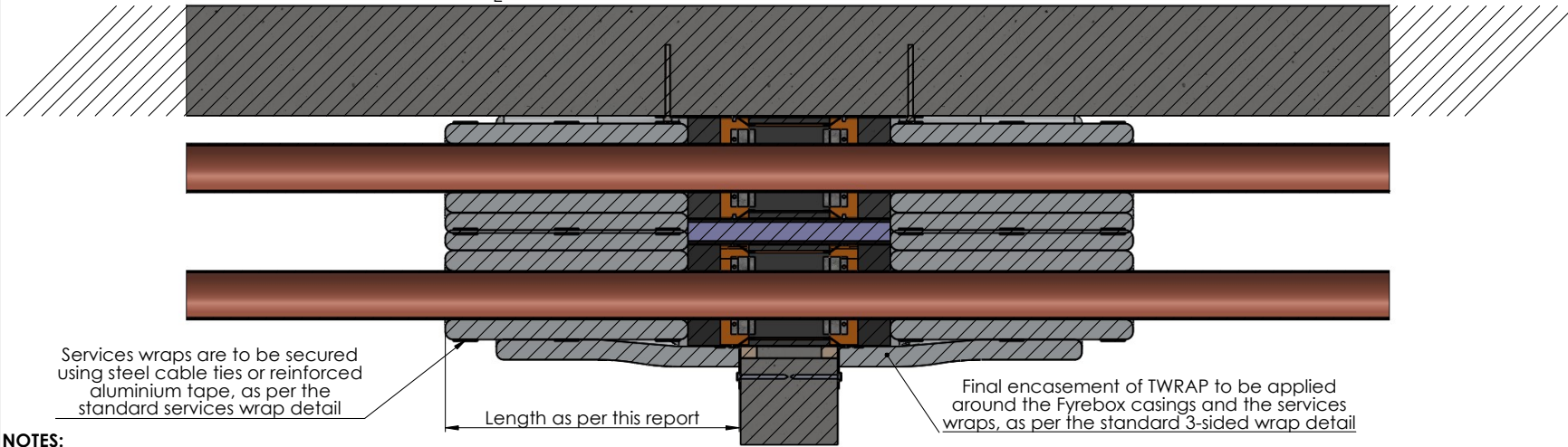
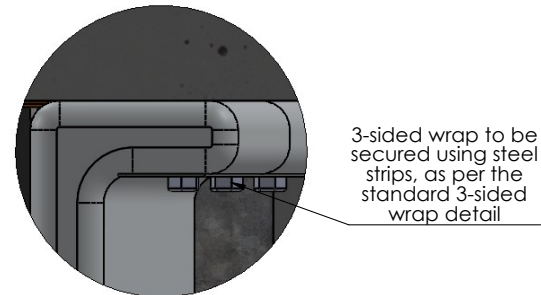
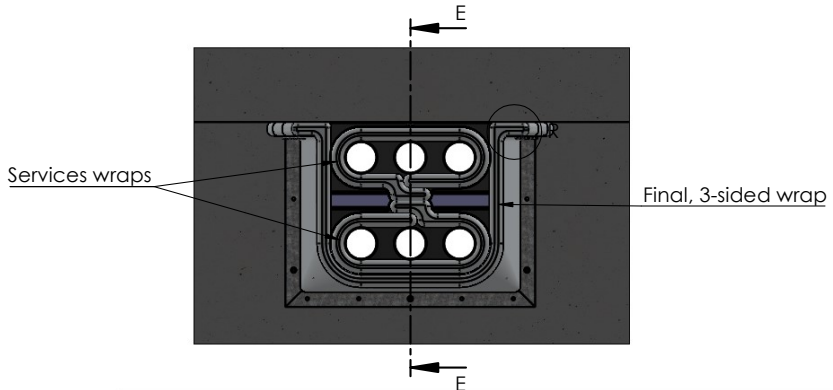

NOTES:

- TWRAP is required on both sides of wall penetrations.
- Cable trays require infill material as-tested before wrapping

Drawing Name: Stacked (Vertical) - TWRAP				Test Standard: AS1530.4	Codes:	Revision:	Date:	No.:	NOTICE:
Project Title: FyreBOX™ Slab-Mount - Generic Install				Fire resistance level:	Drawn By: JC	<small>NOTE: ALL DIMENSIONS ARE IN MILLIMETRES (mm)</small>  Trafalgar Head Office: PO BOX 545 Chester Hill NSW 2162 T: 1800 888 714 F: 1800 201 500 E: info@tfire.com.au W: www.tfire.com.au			
Drawing No. : 18	Sheet: 18 of 19	Date: 27/05/2020	Scale: NTS	Based on Report No.:	Checked By: CT				

Click here to go back to Contents

TWRAP - Stacked (Horizontal)

- TWRAP detail required on each side of wall penetrations and top side of floors

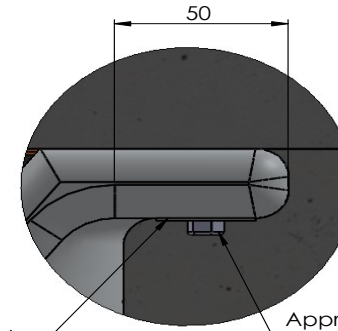
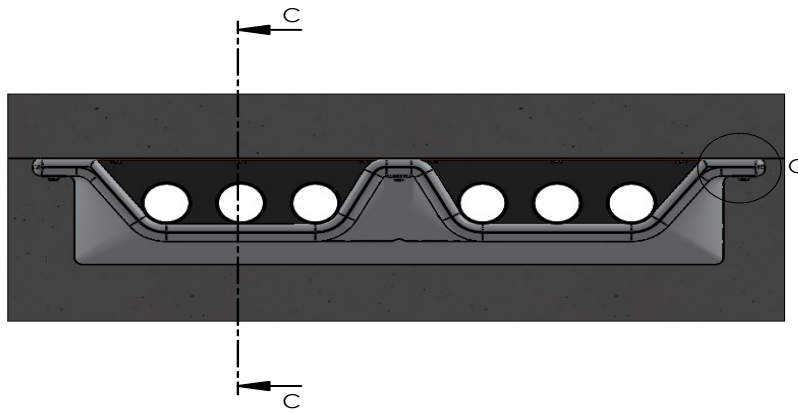

TWRAP secured through flat steel section 30x1x300mm

Approved fixings: 50mm from either end of the TWRAP and one at the midpoint

DETAIL Q

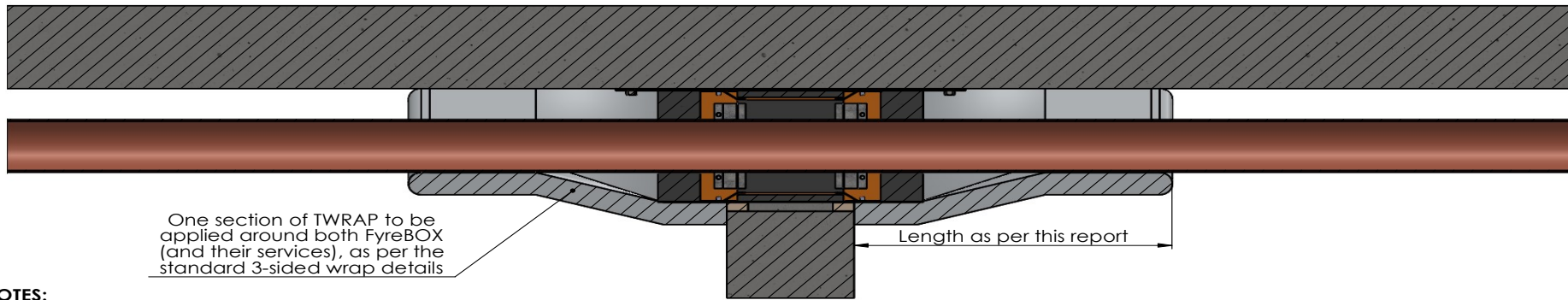

One section of TWRAP to be applied around both FyreBOX (and their services), as per the standard 3-sided wrap details

Length as per this report

NOTES:

- TWRAP is required on both sides of wall penetrations.
- Cable trays require infill material as-tested before wrapping

Drawing Name: Stacked (Horizontal) - TWRAP				Test Standard: AS1530.4	Codes:	Revision:	Date:	No.:	NOTICE:
Project Title: FyreBOX Slab-Mount - Generic Install				Fire resistance level:	Drawn By: JC				<small>NOTE: ALL DIMENSIONS ARE IN MILLIMETRES (mm)</small>  Trafalgar Head Office: PO BOX 545 Chester Hill NSW 2162 T: 1800 888 714 F: 1800 201 500 E: info@tfire.com.au W: www.tfire.com.au
Drawing No. : 17	Sheet: 17 of 19	Date: 27/05/2020	Scale: NTS	Based on Report No.:	Checked By: CT	<input type="checkbox"/> STANDARD DRAWING <input type="checkbox"/> PROJECT DRAWING			

Click here to go back to Contents

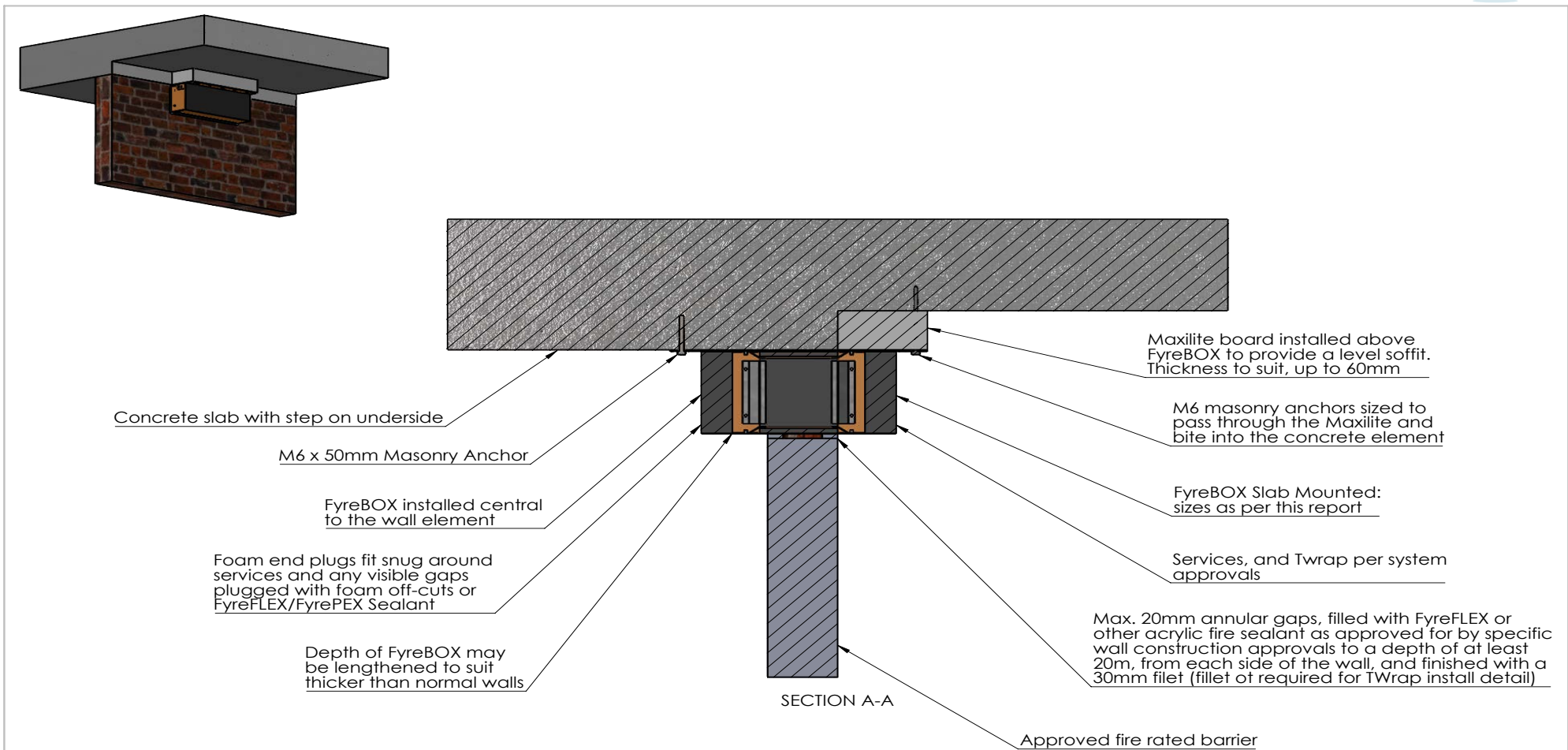

Drawing Name: Stepped Slabs				Test Standard: AS1530.4	Codes:	Revision:	Date:	No.:	NOTICE:
Project Title: FyreBOX Slab Mount - Generic				Fire resistance level:	Drawn By: SM	<small>NOTE: ALL DIMENSIONS ARE IN MILLIMETRES (mm)</small>			
Drawing No. : 1	Sheet: 1 of 1	Date: 1/07/2022	Scale: NTS	Based on Report No.:	Checked By: JH	<input type="checkbox"/> STANDARD DRAWING	 <p>TRAFALGAR FIRE PO BOX 545 Chester Hill NSW 2162 T: 1800 888 714 F: 1800 201 500 E: technical@tgroup.com.au W: www.tfire.com.au</p>		
						<input type="checkbox"/> PROJECT DRAWING			

Click here to go back to Contents

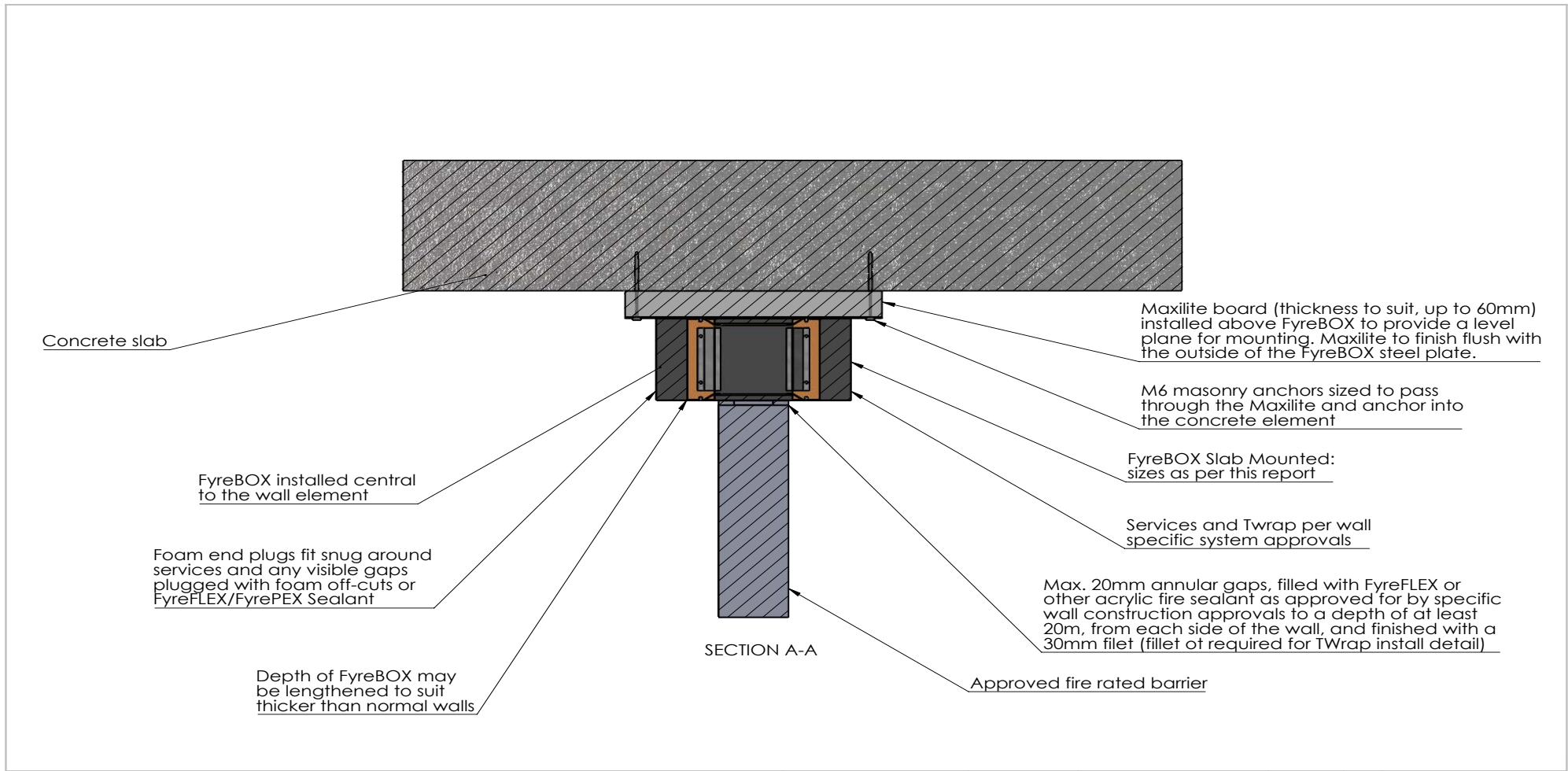

Drawing Name: Oversized Penetration - Height				Test Standard: AS1530.4	Codes:	Revision:	Date:	No.:	NOTICE:
Project Title: FyreBOX Slab Mounted - Generic Install				Fire resistance level:	Drawn By: SM	<small>NOTE: ALL DIMENSIONS ARE IN MILLIMETRES (mm)</small>			
Drawing No. : 1	Sheet: 1 of 2	Date: 11/08/2022	Scale: NTS	Based on Report No.:	Checked By: JH	<input type="checkbox"/> STANDARD DRAWING	 <p>TRAFALGAR FIRE</p> <p><small>Trafalgar Head Office: PO BOX 545 Chester Hill NSW 2162 T: 1800 888 714 F: 1800 201 500 E: technical@group.com.au W: www.tfire.com.au</small></p>		
<input type="checkbox"/> PROJECT DRAWING									

Click here to go back to Contents

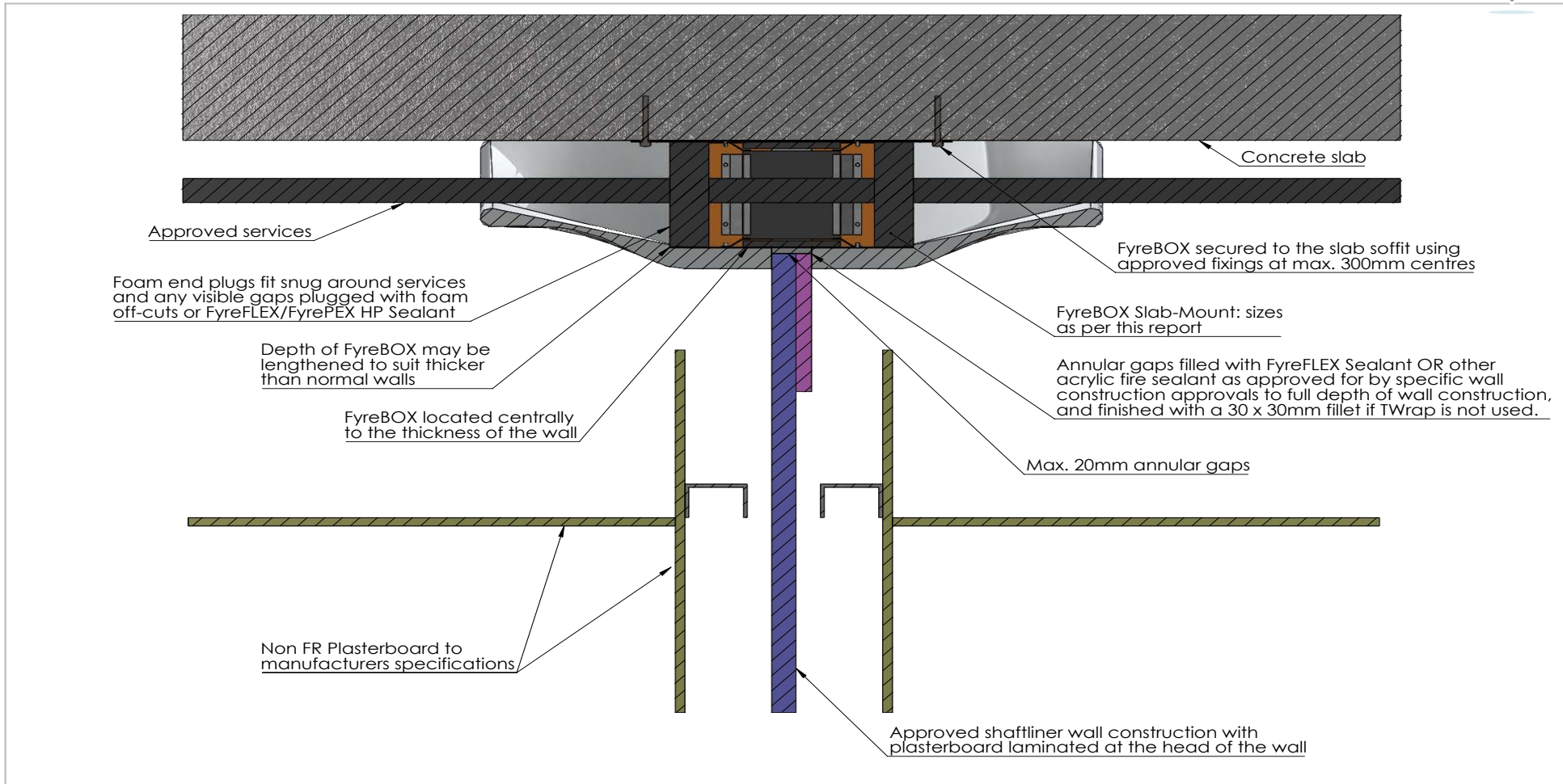

Drawing Name: Head of Party Wall Penetration				Test Standard: AS1530.4	Codes:	Revision:	Date:	No.:	NOTICE:
Project Title: FyreBOX Slab-Mounted - Generic Install				Fire resistance level:	Drawn By: SM	<small>NOTE: ALL DIMENSIONS ARE IN MILLIMETRES (mm)</small>			
Drawing No. : 1	Sheet: 1 of 1	Date: 26/08/2022	Scale: NTS	Based on Report No.:	Checked By: JH	<input type="checkbox"/> STANDARD DRAWING	 TRAFALGAR FIRE PO BOX 545 Chester Hill NSW 2162 T: 1800 888 714 F: 1800 201 500 E: technical@tgroup.com.au W: www.tfire.com.au		
						<input type="checkbox"/> PROJECT DRAWING			