

SuperSTOPPER® Square Mini

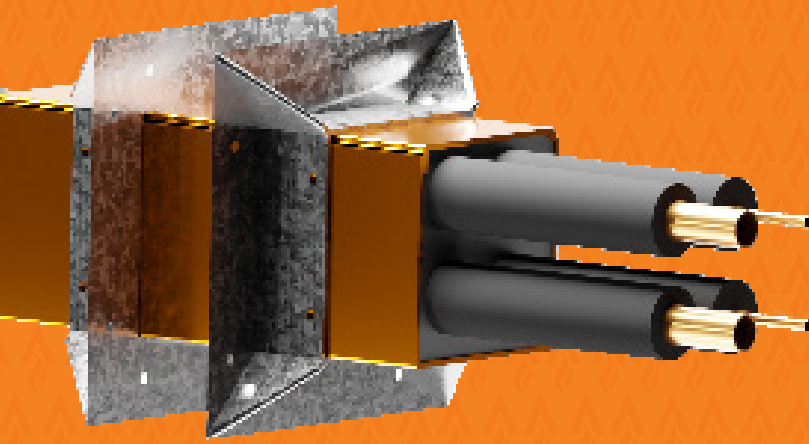

The SuperSTOPPER® Square Mini is an advanced retrofit multi-service penetration system engineered to effectively contain and prevent the spread of fire through narrow service penetrations, all within a remarkably compact design. This innovative product, tested with the Fyre BOX range, has undergone extensive rigorous testing with various combinations of service types and bundles within standard wall, ceiling and floor fire barriers. It proudly stands as one of the most extensively fire-tested solutions globally, boasting industry-leading Fire Resistance Levels (FRLs) of up to -/240/240 (system specific).



Click to Watch Installation Video



KEY FEATURES



- Allows multiple and mixed services to pass through one opening
- Mixed services approved in any quantity or configuration
- Retro-fit or new construction
- Space saving, eliminates the need for 200mm separation between adjacent services
- Tested in Hebel®, single/ double layer plasterboard, Speedpanel® and many other common wall/floor systems
- Friendly FyreFLANGE for mounting
- Fire tested in independent laboratories
- Fire tested on ceilings
- Thoroughly tested to AS1530.4-2014
- No need to frame/line plasterboard wall penetrations

APPLICATIONS



Electricians	Power(AL and Cu core) Data cables Conduits Fibre Cables
Plumbers	Steel and Copper pipes PVC pipes PEX pipes PEX-AL-PEX pipes
HVAC&R	Insulated pipes
Active Fire	Sprinkler pipes Fire cables

TRADES

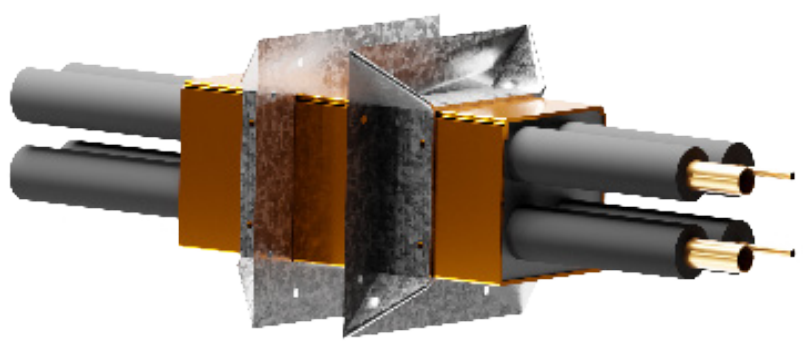

TABLE OF CONTENTS



Section		Page
System Range		3
Benefits		4
FyreFLANGE		5
System Selector		6
Fire Resistance Level		7
FRL Tables	Plasterboard 60min	8
	Plasterboard 90min	9
	Plasterboard 120min	10
	XCEM Alpha Panel Wall 60min	11
	XCEM Alpha Panel Wall 90min	12
	AAC Panel Wall 90min	13
	AAC Panel Wall 120min	14
	Concrete/Masonry 120min	15
	Concrete/Masonry 240min	16
	Speedpanel® 120min	17
	Laminated Shaftwall	18
	Trafalgar COREX Shaftwall	19
	Concrete Floor Slabs 120min	20
	Concrete Floor Slabs 240min	21
	Fire Rated Ceilings	22
Installation	Walls	23
	Ceilings	25
	Floors	27
	Installation Alternatives: FyreBOARD Maxilite®	29
Compliance		30
FAQ		31
Technical Drawings		32

SuperSTOPPER - SQUARE



SuperSTOPPER & FyreFLANGE



Type	Item Number	Dimensions W x H x D	Dimensions
SuperSTOPPER® Square Mini	SUPERSTOPPER-MS65	50 x 250mm	
Square- Mini	SUPERSTOPPER-MS100	100 x 250mm	



SuperSTOPPER® SQUARE MINISYSTEMS COMPONENTS

Item Number	Description	Min Order Qty	Pallet Qty
FLANGE Mini Square	to suit SUPERSTOPPER-MS65	part of assembly	Learn More
FLANGE-R-100mm	to suit SUPERSTOPPER-MS100	part of assembly	Learn More
FYREFLEX 300W/G	300ml White/Grey Cartridge	1	1920
FYREFLEX 600W/G	600ml White/Grey Sausage	1	1040
TWRAP 300	300mm wide, 25mm thick blanket	7620mm long roll	24
TWRAP 450	450mm wide, 25mm thick blanket	7620mm long roll	12
TWRAP 600	600mm wide, 25mm thick blanket	7620mm long roll	12

SUPERSTOPPER

WHY SuperSTOPPER® SQUARE

Trafalgar's SuperSTOPPER® Square Mini Square Mini stands as a cutting-edge solution for containing not just fire but also a range of other crucial elements within service penetrations in modern-day buildings. It was meticulously developed to provide the **ultimate in containment or SUPER containment properties, addressing various needs, including fire, smoke, sound, energy, air leakage, and even the challenges of stringent seismic movements. The SuperSTOPPER is the answer to today's multifaceted containment requirements.**

Innovatively engineered with an intumescent lining, the SuperSTOPPER® Square Mini effectively halts the spread of fire through openings. The FyreBOX Range, akin to versatile fire-rated holes, is designed to adapt seamlessly to diverse scenarios.

The standout feature of the SuperSTOPPER® Square Mini is its fast response to fire exposure. As a fire takes hold, the intumescent material inside the FyreBOX expands swiftly, forming a robust and tight seal around the services, and it's even capable of crushing plastic pipes if necessary. Each SuperSTOPPER® Square Mini is equipped with intumescent foam plugs, further enhancing its reliability, minimizing smoke leakage, and improving acoustic properties. Additionally, this design takes into account future modifications, making it adaptable to changes, additions, and moves in services.

One of the key advantages of the SuperSTOPPER® Square Mini is its extensive fire testing, which covers both empty and full states. Rigorous testing has been undertaken to account for a wide spectrum of service types, including multiple and mixed services. This eliminates the need to separate service penetrations, offering contractors the convenience of running various services through a single penetration.

The Trafalgar SuperSTOPPER® Square Mini redefines fire containment and service penetration solutions in today's modern buildings, providing SUPER containment properties and versatile, easy-to-create openings for a range of purposes, making it an indispensable asset for architects, engineers, and contractors.



FyreFLANGE FOR SuperSTOPPER® Square Mini

SYSTEM APPLICATIONS

SuperSTOPPER® Square Mini systems are suitable for use in any building where penetrations are made through fire rated plasterboard, Speedpanel®, Hebel®, Walsc®, XCEM Alpha Panel®, FyreBOARD Maxilite®, masonry/concrete walls and concrete floors. They have been tested and approved for the following services:

- Electrical (copper and aluminium) cables
- Data, communication cables and NBN and other fibre cables
- Steel and copper pipes
- Pair coil and CHW pipes (copper and PEX)
- Heat trace cables
- CPVC sprinkler pipes
- Small conduits
- PVC pipes (floors only)
- PEX and Gas PEX-AL-PEX
- NBN and other fibre cables

WHAT IS FYREFLANGE?

Every SuperSTOPPER® Square Mini system now includes the Trafalgar FyreFLANGE for seamless integration with the Superstopper. This square and innovative component is designed to accommodate real-world annular gaps in fire barriers. The Trafalgar FyreFLANGE provides a friction-fit solution for securely positioning the SuperSTOPPER® Square Mini without requiring any drilling into the fire barrier. The latest testing has demonstrated that with the FyreFLANGE mounting brackets, the SuperSTOPPER® Square Mini or Maxi can effectively cover annular gaps of up to 20mm, expanding its suitability for a broader range of penetrations. In situations where even larger annular gaps are encountered on-site, you can contact Trafalgar Fire for custom mounting flange systems, or opt for the use of FyreBOARD Maxilite®. This enhanced flexibility makes the SuperSTOPPER® Square Mini system a versatile choice for fire protection needs.



Product	Depth mm	Height mm	FyreFLANGE Dimensions
FyreFLANGE Mini 65	30	30	
FyreFLANGE Mini 100	30	30	

SYSTEM SELECTOR

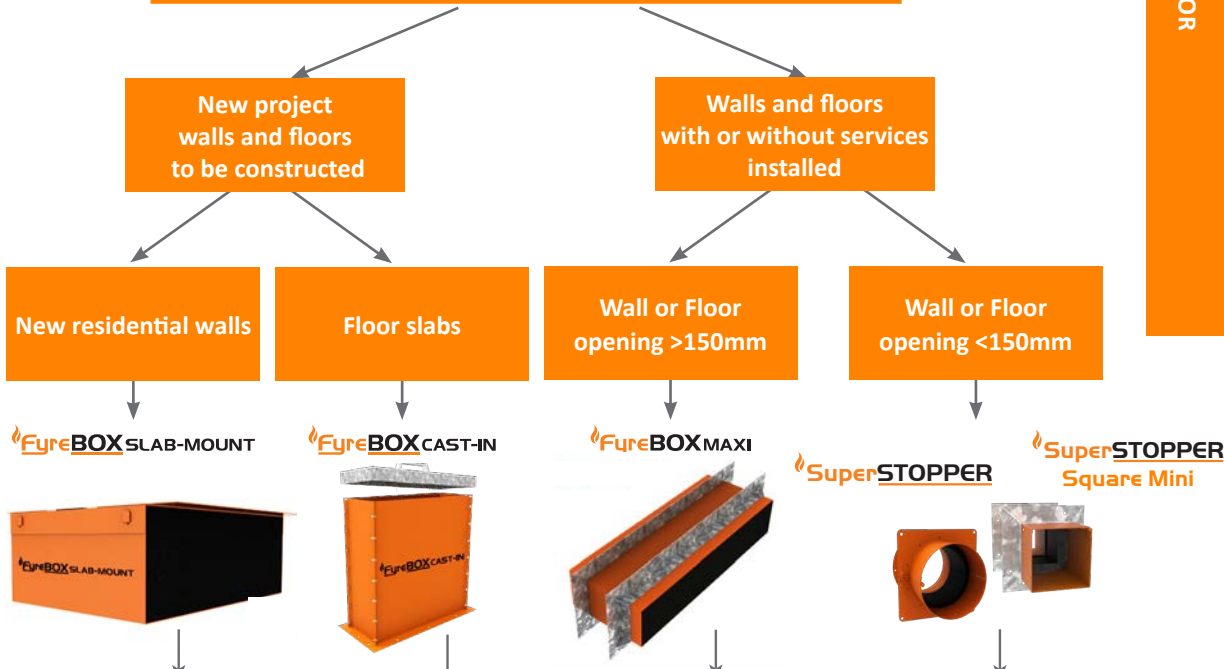

		FyreBOX SLAB-MOUNT	FyreBOX CAST-IN	FyreBOX MAXI	SuperSTOPPER	SuperSTOPPER Square Mini
Installation Prior to Fire Barrier Construction		✓	✓	✗	✗	✗
Hole Cutting Required		✗	✗	✓	✓	✓
Fire Barrier	Floors	Concrete Slab	✗	✓	✓	✓
		FyreSET® Mortar	✗	✓	✗	✗
	Walls	Masonry Walls	✓	✗	✓	✓
		Concrete Walls	✓	✗	✓	✓
		Plasterboard	✓	✗	✓	✓
		Hebel® / Wasc®	✓	✗	✓	✓
		SpeedPanel®	✓	✗	✓	✓
		Alpha Panel®	✓	✗	✓	✓
		COREX walls	✓	✗	✓	✓
		FyreBOARD Maxilite™	✓	✗	✓	✓
	FyreBATT	✗	✗	✗	✓	
	Ceilings	Plasterboard Ceiling	✗	✗	✓	✓
COREX ceilings		✗	✗	✓	✓	
Services	Power Cables	✓	✓	✓	✓	
	Data Cables	✓	✓	✓	✓	
	Cable Trays	✓	✓	✓	✗	
	Steel and Copper Pipes	✓	✓	✓	✓	
	Aluminium Cables	✓	✓	✓	✓	
	CPVC Pipes	✓	✓	✓	✓	
	PVC Pipes	✗	✓	Floors Only	Floors Only	
	PEX	✓	✓	✓	✓	
	PEX-AL-PEX	✓	✓	✓	✓	
	Insulated Copper/PEX	✓	✓	✓	✓	
	Pair Coils	✓	✓	✓	✓	

For full FRL details please consult the relevant technical guide or contact Trafalgar Fire. Fire testing of Trafalgar Fire products is always ongoing.

FIRE RESISTANCE LEVEL

FIRE RATING – HOW IS FIRE PERFORMANCE MEASURED?

An FRL (fire resistance level) is a handy way of summarising the performance of a building element. It consists of 3 numbers, all given in minutes:

FRL 120/120/120

(example)



Structural Adequacy

The ability of the building element to support the weight of adjacent building elements.

ie: a brick wall supporting a concrete floor slab above.



Integrity

The ability of an element to prevent the passage of flames and hot gasses.

ie: a plasterboard wall remaining intact and not allowing holes to form.

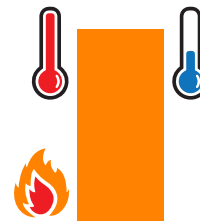

Insulation

The ability of an element to resist heat transfer from the exposed face to the unexposed face.

ie: a bundle of cables remaining below a set temperature limit on the unexposed side of the wall penetration system.

Penetrations are not required to have a Structural Adequacy rating and is usually expressed as a dash. For example, a penetration through a 2-hour load bearing wall would be written as -/120/120.

INTEGRITY

The SuperSTOPPER® Square Mini system will achieve the integrity performance for up to 2 hours physically stopping the direct spread of fire, however the insulation performance of the penetration will be limited to the type of wall being used and conductivity of the services in the penetration.

INSULATION (TEMPERATURE RISE)

Heat transfer via conduction (or heat rise) will occur through the conductive parts of any penetration system. To limit the heat rise through the SuperSTOPPER® Square Mini penetration systems, our 25mm thick TWRAP foil encased blanket can be wrapped around the services and metal casing of the FyreBOX to achieve up to 2 hours of insulation performance. There are some applications that won't require any TWRAP to achieve the full FRL, please refer to the tables below for specific details.

60 MINUTE PLASTERBOARD STUD WALLS -WRAP FREE!

Minimum of 13mm fire grade plasterboard on each face of steel or timber stud, of minimum 64mm thickness with a stated FRL of -/60/60. Please note that plasterboard walls do not require the penetration to be framed and lined when using the Superstopper Square or Circular.

**PATCH FREE!
WRAP FREE!
FRAME FREE!**



Service Type	Service Specification		FRL - WRAP FREE	
			64mm stud*	92mm studs
Plastic Pipes	PVC Pipes	Up to 32mm OD	-/60/30	-/60/60
	PEX Pipes	Up to 20mm	-/60/30	-/60/60
		Up to 32mm	-/60/30	-/60/60
		Up to 32mm with 19mm E-Flex insulation	-/60/30	-/60/60
	PEX-Al-PEX pipes	Up to 25mm	-/60/30	-/60/60
		Up to 32mm	-/60/-	-/60/-*
		Up to 32mm with 19mm E-Flex insulation	-/60/30	-/60/60
cPVC Pipes	Up to 40mm	-/60/-	-/60/-*	
	40mm to 60mm	-/60/30	-/60/60	
Bare Metal Pipes	Copper	Up to 50mm	-/60/-	-/60/-*
	Steel	up to 60mm	-/60/30	-/60/60
Metal Pipes Insulated**	Copper	Up to 50mm OD with PE insulation up to 20mm thick	-/60/30	-/60/30*
		Up to 50mm OD with FR insulation	-/60/30	-/60/60
		Up to 20mm OD with 38mm rockwool-type insulation	-/60/30	-/60/60
	Pair coil	Up to 9.5 & 19mm with 20mm FR insulation (or 13mm PE)	-/60/30	-/60/60
Power Cables - Copper Core	TPS	Up to 12x 2.5mm ² per bundle	-/60/30	-/60/60
	Rigid or Flexible PVC Conduits	Up to 32mm OD (with any size power or comms cables up to 32mm diameter)	-/60/30	-/60/60
	AS1530.4 Appendix D1 cable set	Applies to copper core power cables	-/60/30	-/60/30*
Power Cables - Aluminium Core	Single Core cables	Bundles of up to 3 x 240mm ² , 4 x 120mm ² and 9 x 70mm ² per bundle (16x cables total)	-/60/30	-/60/30*
Communications Cables	RG6 coax	Up to 3x per bundle	-/60/30	-/60/60
	AS1530.4 Appendix D2 cable set	Applies to copper core comms cables	-/60/30	-/60/60
Conduits	Rigid or Flexible PVC Conduits	Up to 32mm OD (with any size power or comms cables up to 32mm diameter)	-/60/30	-/60/60

*TWrap required on these specific services to achieve -/60/60 FRL. Refer to FC10266 for details in specific wall types.

**With or without heat trace cable.

90 MINUTE PLASTERBOARD STUD WALLS

FRAME FREE!

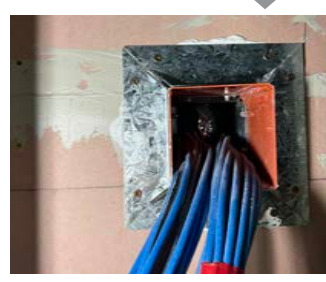

Minimum of 16mm fire grade plasterboard on each face of a steel or timber stud of minimum 64mm thickness, with a stated FRL of -/90/90.

Please note that plasterboard walls do not require the penetration to be framed and lined when using the Superstopper Square or Circular.

Service Type	Service Specification		FRL (Wrap Free)	FRL with TWRAP™	TWRAP™ Length required (mm)
Plastic Pipes	PVC Pipes	Up to 32mm OD	-/90/60	-/90/90	300
	PEX Pipes	Up to 20mm	-/90/60		300
		Up to 32mm	-/90/60		450
		Up to 32mm with 19mm E-Flex insulation	-/90/60		300
		Up to 25mm	-/90/60		300
	PEX-Al-PEX pipes	Up to 32mm	-/90/-		450
		Up to 32mm with 19mm E-Flex insulation	-/90/30		300
		cPVC Pipes	Up to 40mm		-/90/-
	40mm to 60mm		-/90/60		300
	Bare Metal Pipes	Copper	Up to 50mm		-/90/-
Steel		up to 60mm	-/90/30	300	
Metal Pipes Insulated*	Copper	Up to 50mm OD with PE insulation up to 20mm thick	-/90/30	300	
		Up to 50mm OD with FR insulation	-/90/30	300	
		Up to 20mm OD with 38mm rockwool-type insulation	-/90/30	300	
	Pair coil	Up to 9.5 & 19mm with 20mm FR insulation (or 13mm PE)	-/90/30	300	
Power Cables - Copper Core	TPS	Up to 12x 2.5mm ² per bundle	-/90/30	300	
	AS1530.4 Appendix D1 cable set	Applies to copper core power cables	-/90/30	300	
Power Cables Aluminium Core	Single Core cables	Bundles of up to 3 x 240mm ² , 4 x 120mm ² and 9 x 70mm ² per bundle (16x cables total)	-/90/30	300	
Communications Cables	RG6 coax	Up to 3x per bundle	-/90/30	300	
	AS1530.4 Appendix D2 cable set	Applies to copper core comms cables	-/90/30	300	
Conduits	Rigid or Flexible PVC Conduits	Up to 32mm OD (with or without cables)	-/90/60	300	

*Heat trace cables may be installed underneath thermal lagging through a FyreBOX penetration

120 MINUTE PLASTERBOARD STUD WALLS

FRAME FREE!

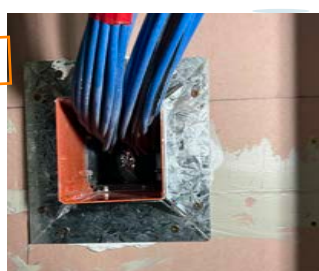

Minimum of 2x13mm fire grade plasterboard on each face of steel or timber stud, of minimum 64mm thickness with a stated FRL of -/120/120. Please note that plasterboard walls do not require the penetration to be framed and lined when using the Superstopper Square or Circular.

Service Type	Service Specification		FRL (Wrap Free)	FRL with TWRAP™ (all studs)	TWRAP™ Length required (mm)
Plastic Pipes	PVC Pipes	Up to 32mm OD	-/120/60	-/120/120	300
	PEX Pipes	Up to 20mm	-/120/60		300
		Up to 32mm	-/120/60		450
	PEX-Al-PEX pipes	Up to 20mm	-/120/60		300
		Up to 32mm	-/120/-		450
	cPVC Pipes	Up to 40mm	-/120/-		300
40mm to 60mm		-/120/60	300		
Bare Metal Pipes	Copper	Up to 50mm	-/120/-		300
	Steel	up to 60mm	-/120/60		300
Metal Pipes Insulated*	Copper	Up to 50mm OD with PE insulation up to 20mm thick	-/120/60		300
		Up to 50mm OD with FR insulation	-/120/60		300
		Up to 20mm OD with 38mm rockwool-type insulation	-/120/60		300
	Pair coil	Up to 9.5 & 19mm with 20mm FR insulation (or 13mm PE)	-/120/60	300	
Power Cables - Copper Core	TPS	Up to 12x 2.5mm ² per bundle	-/120/60	300	
	AS1530.4 Appendix D1 cable set	Applies to copper core power cables	-/120/60	600	
Power Cables Aluminium Core	Single Core cables	Bundles of up to 3 x 240mm ² , 4 x 120mm ² and 9 x 70mm ² per bundle (16x cables total)	-/120/30	300	
Communications Cables	RG6 coax	Up to 3x per bundle	-/120/60	300	
	AS1530.4 Appendix D2 cable set	Applies to copper core comms cables	-/120/60	450	
Conduits	Rigid or Flexible PVC Conduits	Up to 32mm OD (with or without cables)	-/120/60	300	

*Heat trace cables may be installed underneath thermal lagging through a FyreBOX penetration

60 MINUTE XCEM ALPHA PANEL WALLS

Type 1 - 35mm Alpha Panel, framed with stud and lined on the other face with 13mm plasterboard (88mm minimum thickness) shown on the right.

Type 2 - 35mm Alpha Panel, framed with stud on both sides, lined on both faces with 13mm plasterboard (200mm minimum thickness) not shown.



Service Type	Service Specification		FRL - WRAP FREE		FRL with TWRAP™	
			Type 1	Type 2	Both walls	Length required (mm)
Plastic Pipes	PVC Pipes	Up to 32mm OD	-/60/30	-/60/60		300
	PEX Pipes	Up to 20mm	-/60/30	-/60/60		300
		Up to 32mm	-/60/30	-/60/60		450
		Up to 32mm with 19mm E-Flex	-/60/30	-/60/60		300
	PEX-Al-PEX pipes	Up to 25mm	-/60/30	-/60/60		300
		Up to 32mm	-/60/-	-/60/-		450
		Up to 32mm with 19mm E-Flex	-/60/30	-/60/60		300
	cPVC Pipes	Up to 40mm	-/60/-	-/60/-		300
40mm to 60mm		-/60/30	-/60/60	300		
Bare Metal Pipes	Copper	Up to 50mm	-/60/-	-/60/-	300	
	Steel	up to 60mm	-/60/30	-/60/60	300	
Metal Pipes Insulated*	Copper	Up to 50mm OD with PE insulation up to 20mm thick	-/60/30	-/60/30	-/60/60	300
		Up to 50mm OD with FR insulation	-/60/30	-/60/60		300
		Up to 20mm OD with 38mm rockwool-type insulation	-/60/30	-/60/60		300
	Pair coil	Up to 9.5 & 19mm with 20mm FR insulation (or 13mm PE)	-/60/30	-/60/60		300
Power Cables - Copper Core	TPS	Up to 12x 2.5mm ² per bundle	-/60/30	-/60/60	300	
	AS1530.4 Appendix D1 cable set	Applies to copper core power cables and cable trays up to 1000mm wide	-/60/30	-/60/30	300	
Power Cables Aluminium Core	Single Core cables	Bundles of up to 3 x 240mm ² , 4 x 120mm ² and 9 x 70mm ² per bundle (16x cables total)	-/60/30	-/60/30	300	
Communications Cables	RG6 coax	Up to 3x per bundle	-/60/30	-/60/60	300	
	AS1530.4 Appendix D2 cable set	Applies to copper core comms cables, including cable trays up to 1000mm wide	-/60/30	-/60/60	300	
Conduits	Rigid or Flexible PVC Conduits	Up to 32mm OD (with or without cables)	-/60/30	-/60/60	300	

*Heat trace cables may be installed underneath thermal lagging through a FyreBOX penetration

90 MINUTE XCEM ALPHA PANEL WALLS

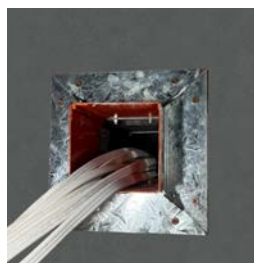

Type 3 - 35mm Alpha Panel, framed with stud and lined on the other face with 16mm fire grade plasterboard (91mm minimum thickness).

Type 4 - 35mm Alpha Panel laminated with 16mm fire grade plasterboard, shown on the right.

Service Type	Service Specification		FRL (Wrap Free)**		FRL with TWRAP™	
			Type 3	Type 4	Both walls	Length required (mm)
Plastic Pipes	PVC Conduits	Up to 32mm OD	-/90/60	-/90/30	-/90/90	450
	PEX Pipes	Up to 20mm	-/90/60	-/90/30		450
		Up to 32mm	-/90/60	-/90/30		450
		Up to 32mm with 19mm E-Flex	-/90/60	-/90/30		450
	PEX-Al-PEX pipes	Up to 25mm	-/90/60	-/90/30		450
		Up to 32mm	-/90/-	-/90/-		450
		Up to 32mm with 19mm E-Flex insulation	-/90/30	-/90/30		450
	cPVC Pipes	Up to 40mm	-/90/-	-/90/-		450
40mm to 60mm		-/90/60	-/90/30	450		
Bare Metal Pipes	Copper	Up to 50mm	-/90/-	-/90/30		450
	Steel	up to 60mm	-/90/30	-/90/30		450
Metal Pipes Insulated*	Copper	Up to 50mm OD with PE insulation up to 20mm thick	-/90/30	-/90/30		450
		Up to 50mm OD with FR insulation	-/90/30	-/90/30		450
		Up to 20mm OD with 38mm rockwool-type insulation	-/90/30	-/90/30		450
	Pair coil	Up to 9.5 & 19mm with 20mm FR insulation (or 13mm PE)	-/90/30	-/90/30		450
Power Cables - Copper Core	TPS	Up to 12x 2.5mm ² per bundle	-/90/30	-/90/30	450	
	AS1530.4 Appendix D1 cable set	Applies to copper core power cables and cable trays up to 1000mm wide	-/90/30	-/90/30	450	
Power Cables Aluminium Core	Single Core cables	Bundles of up to 3 x 240mm ² , 4 x 120mm ² and 9 x 70mm ² per bundle (16x cables total)	-/90/30	-/90/30	450	
Communications Cables	RG6 coax	Up to 3x per bundle	-/90/30	-/90/30	450	
	AS1530.4 Appendix D2 cable set	Applies to copper core comms cables, including cable trays up to 1000mm wide	-/90/30	-/90/30	450	
Conduits	Rigid or Flexible PVC Conduits	Up to 32mm OD (with or without cables)	-/90/60	-/90/30	450	

*Heat trace cables may be installed underneath thermal lagging through a FyreBOX penetration
 **Wrap free FRL's require a patch of 60mm Maxilite board 100mm strips on one side of the wall.

90 MINUTE AAC PANELS

Hebel, Wasc or other AAC panels 75mm thick with a stated FRL up to -/90/90. Note if this wall is used for a-/60/60 apartment entry, please refer to page 9.



Service Type	Service Specification		FRL - WRAP FREE	FRL-With 300mm TWRAP
Plastic Pipes	PVC Pipes	Up to 32mm OD	-/90/30	-/90/90
	PEX Pipes	Up to 20mm	-/90/30	-/90/90
		Up to 32mm	-/90/30	-/90/90 (450mm TWrap)
		Up to 32mm with 19mm E-Flex insulation	-/90/30	-/90/90
	PEX-Al-PEX pipes	Up to 20mm	-/90/30	-/90/90
		Up to 25mm	-/90/30	-/90/90
		Up to 32mm	-/90/0	-/90/90 (450mm TWrap)
		Up to 32mm with 19mm E-Flex insulation	-/90/30	-/90/90
	cPVC Pipes	Up to 40mm	-/90/0	-/90/90
		40mm to 60mm	-/90/30	-/90/90
Bare Metal Pipes	Copper	Up to 50mm	-/90/0	-/90/90
	Steel	up to 60mm	-/90/30	-/90/90
Metal Pipes Insulated*	Copper	Up to 50mm OD with PE insulation up to 20mm thick	-/90/30	-/90/90
		Up to 50mm OD with FR insulation	-/90/30	-/90/90
		Up to 20mm OD with 38mm rockwool-type insulation	-/90/30	-/90/90
	Pair coil	Up to 9.5 & 19mm with 13mm PE insulation	-/90/30	-/90/90
		Up to 9.5 & 19mm with 20mm FR insulation	-/90/30	-/90/90
Power Cables - Copper Core	TPS	Up to 12x 2.5mm ² per bundle	-/90/30	-/90/90
	AS1530.4 Appendix D1 cable set	Applies to copper core power cables	-/90/30	-/90/90
	Rigid or Flexible PVC Conduits	Up to 32mm OD (with any size power or comms cables up to 32mm diameter)	-/90/30	-/90/90
Power Cables Aluminium Core	Single Core cables	Bundles of up to 3 x 240mm ² , 4 x 120mm ² and 9 x 70mm ² per bundle (16x cables total)	-/90/30	-/90/90
Communications Cables	RG6 coax	Up to 3x per bundle	-/90/30	-/90/90
	AS1530.4 Appendix D2 cable set	Applies to copper core comms cables	-/90/30	-/90/90
Conduits	Rigid or Flexible PVC Conduits	Up to 32mm OD (with any size power or comms cables up to 32mm diameter)	-/90/30	-/90/90

120 MINUTE AAC PANELS

Hebel, Wasc or other AAC panels 75mm thick with a stated FRL up to -/120/120.



Service Type	Service Specification		FRL (Wrap Free)	FRL with TWRAP™	TWRAP™ Length required (mm)
Plastic Pipes	PVC pipes	Up to 32mm OD	-/120/30	-/120/120	300
	PEX Pipes	Up to 20mm	-/120/30		300
		Up to 32mm	-/120/30		450
	PEX-Al-PEX pipes	Up to 20mm	-/120/30		300
		Up to 25mm	-/120/30		450
		Up to 32mm	-/120/0		450
	cPVC Pipes	Up to 40mm	-/120/0		300
Up to 60mm		-/120/30	300		
Bare Metal Pipes	Copper	Up to 50mm	-/120/0		300
	Steel	up to 60mm	-/120/30		300
Metal Pipes Insulated*	Copper	Up to 50mm OD with PE insulation up to 20mm thick	-/120/30		300
		Up to 50mm OD with FR insulation	-/120/30		300
		Up to 20mm OD with 38mm rockwool-type insulation	-/120/30		300
	Pair coil	Up to 9.5 & 19mm with 13mm FR insulation	-/120/30		300
		Up to 9.5 & 19mm with 20mm FR insulation	-/120/30	300	
Power Cables - Copper Core	TPS	Up to 12x 2.5mm ² per bundle	-/120/30	300	
	AS1530.4 Appendix D1 cable set	Applies to copper core power cables	-/120/30	600#	
Power Cables Aluminium Core	Single Core cables	Bundles of up to 3 x 240mm ² , 4 x 120mm ² and 9 x 70mm ² per bundle (16x cables total)	-/120/30	300	
Communications Cables	RG6 coax	Up to 3x per bundle	-/120/30	300	
	AS1530.4 Appendix D2 cable set	Applies to copper core comms cables	-/120/30	450#	
Conduits	Rigid or Flexible PVC Conduits	Up to 32mm OD (with or without cables)	-/120/60	300	

*With or without heat trace cable

#With 300mm of loose TWRap infill packed around the services within the wrap.

120 MINUTE CONCRETE, MASONRY AND PERMANANT FORMWORK WALLS

Walls designed as per AS3600 or AS3700 (or otherwise fire tested to achieved the required FRL with a minimum thickness as per the 90mm) including Dincel, AFS, Logically etc.



Service Type	Service Specification		FRL (Wrap Free)	FRL with TWRAP™ (all studs)	TWRAP™ Length required (mm)
Plastic Pipes	PVC Pipes	Up to 32mm OD	-/120/60	-/120/120	300
	PEX Pipes	Up to 20mm	-/120/60		300
		Up to 32mm	-/120/60		450
	PEX-Al-PEX pipes	Up to 20mm	-/120/60		300
		Up to 25mm	-/120/60		450
		Up to 32mm	-/120/0		450
	cPVC Pipes	Up to 40mm	-/120/0		300
40mm to 60mm		-/120/60	300		
Bare Metal Pipes	Copper	Up to 50mm	-/120/0		300
	Steel	up to 60mm	-/120/60		300
Metal Pipes Insulated*	Copper	Up to 50mm OD with PE insulation up to 20mm thick	-/120/60		300
		Up to 50mm OD with FR insulation	-/120/60		300
		Up to 20mm OD with 38mm rockwool-type insulation	-/120/60		300
	Pair coil	Up to 9.5 & 19mm with 13mm FR insulation	-/120/60		300
		Up to 9.5 & 19mm with 20mm FR insulation	-/120/60	300	
Power Cables - Copper Core	TPS	Up to 12x 2.5mm ² per bundle	-/120/60	300	
	AS1530.4 Appendix D1 cable set	Applies to copper core power cables	-/120/60	600	
Power Cables Aluminium Core	Single Core cables	Bundles of up to 3 x 240mm ² , 4 x 120mm ² and 9 x 70mm ² per bundle (16x cables total)	-/120/30	300	
Communications Cables	RG6 coax	Up to 3x per bundle	-/120/60	300	
	AS1530.4 Appendix D2 cable set	Applies to copper core comms cables,	-/120/60	450	
Conduits	Rigid or Flexible PVC Conduits	Up to 32mm OD (with or without cables)	-/120/60	300	

*With or without heat trace cable.

240 MINUTE CONCRETE, MASONRY AND PERMANANT FORMWORK WALLS



Walls designed as per AS3600 or AS3700 or otherwise fire tested to achieve an FRL of at least -/240/240, including Dintel, AFS, Logically etc.

Service Type	Service Specification		FRL no wrap required	FRL with TWRAP	TWRAP Length required
Plastic Pipes	uPVC conduits Rigid or flexible (with or without cables)	up to 25mm OD	-/240/120	Wrap Free	-
Bare Metal Pipes	Copper pipes	up to 50mm OD	-/240/-	-/240/120	300mm
	Steel pipes	up to 50mm OD	-/240/60	-/240/120	300mm
Insulated Metal pipes	Copper pipes	up to 50mm OD with PE insulation up to 20mm thick	-/120/60	-/120/120	300mm
		up to 50mm OD with FR insulation	-/120/60	-/120/120	300mm
		up to 20mm OD with rockwool-type insulation	-/120/60	-/120/120	300mm
	2x Pair Coil	Up to 9.5 and 19mm OD with FR insulation up to 20mm thick	-/240/180	Wrap Free	-
	Pair coil pipes	up to 9.5 and 19mm OD with PE insulation up to 13mm thick	-/240/120	-/120/120	300mm
up to 9.5 and 19mm OD with FR insulation up to 20mm thick		-/240/120	-/120/120	300mm	
Power Cables	5 x 19mm OD 3C+E copper cables		-/240/180	Wrap Free	-
	Three core and Earth copper core cables up to 185mm ² (up to 54mm diameter)		-/240/60	-/120/120	600mm
	All other copper core power cables		-/240/60	-/120/120	600mm
Comms Cables	20 x CAT6 cable bundle		-/240/180	Wrap Free	-
	All other copper core power cables		-/120/60	-/120/120	450mm
PVC conduits	uPVC conduits Rigid or flexible (with or without cables)	Up to 25mm OD	-/240/180	Wrap Free	-

Where TWRAP is required for increased insulation performance, it is to be installed on both sides of the wall.

SPEEDPANEL® WALLS

Speedpanel walls of thickness ranging from 51mm (-/60/60), 64mm (-/90/90) and 78mm (-/120/120).

Note 51mm and 64mm Speedpanel walls required additional patch of 30mm Maxilite board on one side of the wall.



Service Type	Service Specification		51mm Speedpanel + 30mm Maxilite	64mm Speedpanel + 30mm Maxilite	78mm Speedpanel	TWrap Length required (mm)
Plastic Pipes	PVC pipes	Up to 32mm OD				300
	PEX Pipes	Up to 20mm				300
		Up to 32mm				450
		Up to 32mm with 19mm E-Flex**				450
		Up to 20mm				300
	PEX-AL-PEX pipes	Up to 32mm				450
		Up to 32mm with 19mm E-Flex**				450
		cPVC Pipes				Up to 40mm
Bare Metal Pipes		Up to 60mm				300
	Copper	Up to 50mm				300
Metal Pipes Insulated#	Copper	Up to 50mm OD with PE insulation up to 20mm thick	-/60/60	-/90/90	-/120/120	300
		Up to 50mm OD with FR insulation				300
		Up to 20mm OD with 38mm rockwool-type insulation				300
	Pair coil	Up to 9.5 & 19mm with 13mm PE insulation				300
		Up to 9.5 & 19mm with 20mm FR insulation				300
	Power Cables - Copper Core	TPS				Up to 12x 2.5mm ² per bundle
AS1530.4 Appendix D1 cable set		Applies to copper core power cables				600*
Power Cables Aluminium Core	Single Core cables	Bundles of up to 3 x 240mm ² , 4 x 120mm ² and 9 x 70mm ² per bundle (16x cables total)				300
Communications Cables	RG6 coax	Up to 3x per bundle				300
	AS1530.4 Appendix D2 cable set	Applies to copper core comms cables				450*
Conduits	Rigid or Flexible PVC Conduits	Up to 32mm OD (with or without cables)				300

*300mm loose TWrap infill underneath Twrap

** Maximum FRL-/90/90

#With or without heat trace cable

For specific service based FRL's without using TWrap, refer to report FC10266

LAMINATED PLASTERBOARD SHAFT WALLS

Minimum of 3x fire grade plasterboard on one side of a steel stud with a stated FRL of 90 or 120 minutes. FyreBOX penetration thickened with 60mm Maxilite in 100mm strips on one side of the penetration.



Service Type	Service Specification		Plasterboard outside minimum 64mm stud (FRL wrap Free)		FRL with TWRAP	TWrap Length required (mm)
			3x13mm plaster	3x16mm plaster		
Plastic Pipes	PVC Conduits	Up to 32mm OD	-/90/30	-/120/30	-/120/120 (Limited to the FRL of the wall)	300
	PEX Pipes	Up to 20mm	-/90/30	-/120/30		300
		Up to 32mm	-/90/30	-/120/30		450
		Up to 32mm with 19mm E-Flex insulation	-/90/30	Not approved		300 (-/90/90 only)
	PEX-Al-PEX pipes	Up to 25mm	-/90/30	-/120/30		450
		Up to 32mm	-/90/-	-/120/30		450
		Up to 32mm with 19mm E-Flex insulation	-/90/30	Not approved		300 (-/90/90 only)
	cPVC Pipes	Up to 40mm	-/90/-	-/120/-		300
40mm to 60mm		-/90/30	-/120/30	300		
Bare Metal Pipes	Copper	Up to 50mm	-/90/-	-/120/-		300
	Steel	up to 60mm	-/90/30	-/120/30		300
Metal Pipes Insulated**	Copper	Up to 50mm OD with PE insulation up to 20mm thick	-/90/30	-/120/30		300
		Up to 50mm OD with FR insulation	-/90/30	-/120/30		300
		Up to 20mm OD with 38mm rockwool-type insulation	-/90/30	-/120/30		300
	Pair coil	Up to 9.5 & 19mm with 20mm FR insulation (or 13mm PE)	-/90/30	-/120/30		300
Power Cables - Copper Core	TPS	Up to 12x 2.5mm ² per bundle	-/90/30	-/120/30	300	
	AS1530.4 Appendix D1 cable set	Applies to copper core power cables	-/90/30	-/120/30	600**	
Power Cables Aluminium Core	Single Core cables	Bundles of up to 3 x 240mm ² , 4 x 120mm ² and 9 x 70mm ² per bundle (16x cables total)	-/90/30	-/120/30	300	
Communications Cables	RG6 coax	Up to 3x per bundle	-/90/30	-/120/30	300	
	AS1530.4 Appendix D2 cable set	Applies to copper core comms cables, including cable trays up to 1000mm wide	-/90/30	-/120/30	450	
Conduits	Rigid or Flexible PVC Conduits	Up to 32mm OD (with or without cables)	-/90/30	-/120/30	300	

TRAFALGAR COREX SHAFT WALLS

2x laminated Corex boards fixed to one side of a 64mm steel stud. FRL of the wall is related to thickness of the Corex facings as shown in the table. [Click here for the Corex Shaft Wall technical Manual.](#)

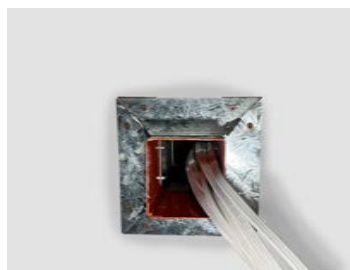

Service Type	Service Specification		Corex Board Specification & FyreBOX Penetration FRL*			TWrap Length required (mm)
			2x15mm	2x20mm	2x25mm	
Plastic Pipes	PVC Pipes	Up to 32mm OD				450
	PEX Pipes	Up to 20mm				450
		Up to 32mm				450
		Up to 32mm with 19mm E-Flex insulation				450
	PEX-Al-PEX pipes	Up to 20mm				450
		Up to 25mm				450
		Up to 32mm				450
		Up to 32mm with 19mm E-Flex insulation				450
	cPVC Pipes	Up to 40mm				450
		40mm to 60mm				450
Bare Metal Pipes	Copper	Up to 50mm				450
	Steel	up to 60mm				450
Metal Pipes Insulated**	Copper	Up to 50mm OD with PE insulation up to 20mm thick	-/60/60	-/90/90	-/120/120	450
		Up to 50mm OD with FR insulation				450
		Up to 20mm OD with 38mm rockwool-type insulation				450
	Pair coil	Up to 9.5 & 19mm with 13mm PE insulation				450
		Up to 9.5 & 19mm with 20mm FR insulation				450
Power Cables - Copper Core	TPS	Up to 12x 2.5mm ² per bundle				450
	AS1530.4 Appendix D1 cable set	Applies to copper core power cables and cable trays up to 1000mm wide				450
Power Cables Aluminium Core	Single Core cables	Bundles of up to 3 x 240mm ² , 4 x 120mm ² and 9 x 70mm ² per bundle (16x cables total)				450
Communications Cables	RG6 coax	Up to 3x per bundle				450
	AS1530.4 Appendix D2 cable set	Applies to copper core comms cables, including cable trays up to 1000mm wide				450
Conduits	Rigid or Flexible PVC Conduits	Up to 32mm OD (with or without cables)				450

For Corex walls, the wall must be thickened on one side with 100mm wide Maxilite, 60mm thick around the penetration.

*For specific service based FRL's without using TWrap, refer to report FC10266.

**Heat trace cables may be installed underneath thermal lagging through a FyreBOX penetration

2 HOUR FRL SLABS MINIMUM THICKNESS 120MM

Concrete floors with our without steel decks with an effective minimum thickness of 120mm.



Service Type	Service Specification		FRL – Wrap Free	FRL – With TWrap	TWrap Length (mm)
Blank (No Services)	No Services		-/120/-	-/120/120	300
Plastic Pipes	PEX pipes	up to 32mm OD	-/120/-	-/120/120	450
	PEX-Al-PEX pipes	up to 32mm OD	-/120/-	-/120/120	450
	PVC pipes	up to 80mm OD	-/120/-	-/120/120	300
Bare Metal Pipes	Copper pipes	up to 42mm OD	-/120/-	-/120/120	450
		up to 100mm OD	-/120/-	-/120/120	600 1 st Layer + 450 2 nd Layer^
	Steel pipes	up to 50mm OD	-/120/-	-/120/120	450
		up to 100mm OD	-/120/-	-/120/120	600 1 st Layer + 450 2 nd Layer^
Metal Pipes Insulated*	Copper pipes	up to 50mm OD with FR insulation	-/120/60	-/120/120	300
	Stainless Steel pipes	Up to 50mm OD with EPS or PE insulation and rockwool	-/120/60	-/120/120	300
	Pair Coils	Up to 9.5 & 19mm with up to 20mm FR insulation (OR 13mm PE) with 10mm OD cable	-/120/60	-/120/120	450
Power Cables - Aluminium Core***	4x Core AL cables	Up to 4 x 240mm ² + optional 90mm ²	-/90/30	-/120/120	300
	Single core AL cables	Up to 1x 400mm ²	N/a	-/120/120	300
Power Cables	TPS cables	Up to 10x per bundle	-/120/60	-/120/120	300
	3x Core cables	19mm diam 3C + E cables	-/120/60	-/120/120	300
	AS1530.4 Appendix D cable set (no cable tray)	Applies to all copper core power cables	-/120/30	-/120/120	600 (min. 190mm slab)
Comms Cables	AS1530.4 Appendix D cable sets	Copper core comms cables	-/120/60	-/120/120	450 (Min.190mm slab) Or 600mm
	Fibre Optic cables	NBN grade cable	-/120/30	-/120/120	300
	CAT6	Up to 150x per bundle	-/120/60	-/120/120	300
Conduits	uPVC Conduits Rigid or Flexible	Up to 32mm OD (with or without cables)	-/120/60	-/120/120	300
Drinks python***	Lagged post mix lines	90mm OD 10x post mix lines with 19mm FR thermal lagging	-/120/120	-/120/120	Wrap Free

^Large metal pipes require 2 layers of TWrap. Refer to [page 21](#)

*With or without heat trace cable

3-4 HOUR FRL SLABS MINIMUM THICKNESS 175MM

Concrete floors with our without steel decks with an effective minimum thickness of 175mm.



Service Type	Service Specification		FRL – Wrap Free	FRL – With TWrap	TWrap Length (mm)
Metal Pipes	Steel Pipes	Up to 50mm	-/120/-	-/240/120	450
Insulated Metal Pipes	Stainless Steel Pipes	Up to 50mm OD with EPS or PE insulation and rockwool	-/240/60	-/240/240	300
Power Cables	3x Core	Up to 2x 19mm 3C + E per bundle	-/240/60	-/240/120	300
Comms Cables	CAT6	Up to 5x per bundle	-/240/60	-/240/120	300
Power Cables - Aluminium Core	Single core AL cables	Up to 1x 400mm ²	N/a	-/180/180*	300
Drinks python***	Lagged post mix lines	90mm OD 10x post mix lines with 19mm FR thermal lagging	-/240/240	-/240/240	Wrap Free

Where TWRAP is required for increased insulation performance, it is to be installed on top side of the slab. FyreWrap® Elite 1.5 may be substituted for any of the above TWRAP applications.

THE CHALLENGE WITH 3-4 HOUR FRL'S

After two hours of the AS1530.4 fire test, the temperatures inside the furnace will increase from 1050 to 1200 degree's C which is above the melting points of some metals like copper. Therefore, most copper based building services (cables and copper pipes) are practically very difficult to remain under the insulation (heat rise) criteria past 2 hours.

In this case, please refer to our specific **3-4 hour FRL Applications Manual** for specific advice on how fire engineering can deal with these penetrations as an alternate solution to address the building code's performance requirements.

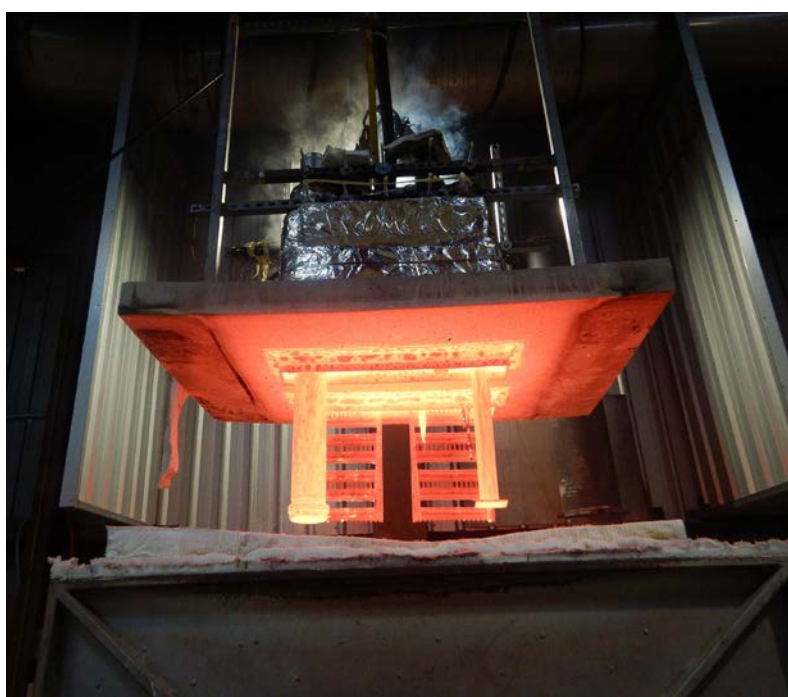

[Click Here](#)

[Download 3-4 Hour Penetrations Applications Manual](#)

FIRE RATED CEILINGS

The SuperSTOPPER® Square Mini systems are tested and approved for use in various ceilings including Corex board and plasterboard ceilings that meet the requirements listed. Penetrations MUST be lined with 60mm Maxilite board as shown in the installation drawings.

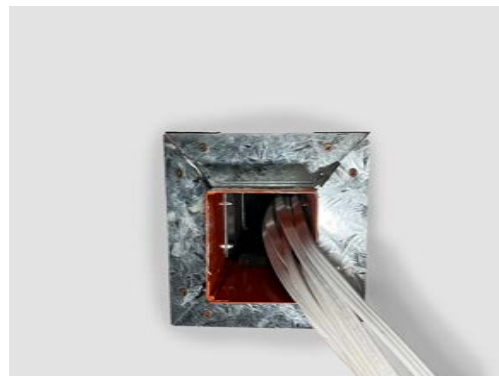

Timber or steel framed ceiling construction

Ceiling facing thickness	FRL	RISF
Minimum thickness 16mm	-/30/30	30mins
Minimum thickness 29mm	-/60/60	60mins
Minimum thickness 32mm	-/90/90	60mins
Minimum thickness 48mm	-/120/120	60mins

The FRL's listed below against service penetrations are limited to the FRL and RISF rating of the ceiling system they are installed into.

Service Type	Service Specification		FRL – Wrap Free	RISF – With TWrap	TWrap Length (mm)
Plastic Pipes	PEX pipes	up to 32mm OD	-/120/120	-/120/120	300
	PEX-Al-PEX pipes	up to 32mm OD	-/120/120	-/120/120	300
	PVC pipes	up to 80mm OD	-/120/120	-/120/120	300
Bare Metal Pipes	Copper pipes	up to 42mm OD	-/120/-	-/120/120	300
		up to 100mm OD	-/120/-	-/120/120	600
	Steel pipes	up to 50mm OD	-/120/-	-/120/120	300
		up to 100mm OD	-/120/-	-/120/120	600
Metal Pipes Insulated*	Copper pipes	up to 50mm OD with FR insulation	-/120/120	-/120/120	300
	Stainless Steel pipes	Up to 50mm OD with EPS or PE insulation and rockwool	-/120/120	-/120/120	300
	Pair Coils	Up to 9.5 & 19mm with up to 20mm FR insulation (OR 13mm PE) with 10mm OD cable	-/120/120	-/120/120	300
Power Cables - Aluminium Core***	4x Core AL cables	Up to 4 x 240mm ² + optional 90mm ²	-/90/30	-/90/90	300
	Single core AL cables	Up to 1x 400mm ²	-/90/30	-/90/90	300
Power Cables - Copper Core	TPS cables	Up to 10x per bundle	-/120/120	-/120/120	300
	3x Core cables	19mm diam 3C + E cables	-/120/120	-/120/120	300
	AS1530.4 Appendix D cable sets on cable trays	Applies to all copper core power cables and cable trays up to 1000mm wide	-/120/120	-/120/120	600
Comms Cables	AS1530.4 Appendix D cable sets on cable trays	Copper core comms cables and cable trays up to 1000mm wide	-/120/30	-/120/120	450
	Fibre Optic cables	NBN grade cable	-/120/120	-/120/120	300
	CAT6	Up to 150x per bundle	-/120/120	-/120/120	300
Conduits	uPVC Conduits Rigid or Flexible	Up to 32mm OD (with or without cables)	-/120/120	-/120/120	300

INSTALLATION

SuperSTOPPER® Square Mini in Walls

ALL WALLS

CUT HOLE



Cut a hole in the barrier allowing for an appropriate annular gap (5-20mm between the edge of the hole and the walls of the SuperSTOPPER® Square Mini). Example: for a 100mm SuperSTOPPER® Square Mini 100 (MS100), cut a maximum hole 140mm diameter.

Note SuperSTOPPER® Square Mini's do not require openings to be framed with stud or lined

INSERT AND SEAL



Insert the SuperSTOPPER® Square Mini into the hole, and centre it to the wall or floor. **NOTE:** if barrier is too thick, contact Trafalgar Fire for alternative installations.

Seal the annular gap around the FyreBOX with FyreFLEX® Sealant to 20mm depth, on both sides of the wall.

Please note: The SuperSTOPPER® Square Mini can be installed before or after the services are in place, the hinged design allows for the box to be retro fit around services, or services can be run once the box is in place.

FLANGES



Install the steel mounting flange to both sides of the wall, or just the **top side** of a concrete floor. When fitting the flanges, use the fixings to suit the wall or floor type as per table 1 on [page 24](#), using 2x fixings per flange.

FOAM



Cut a slit through the FyreBOX foam plug inserts and notch out holes to suit the services that are installed, then fit the foam in the box around the services. Foam is needed on both sides of a wall, but only the **top side** of a concrete slab penetration.

The fit should be snug, fill any gaps with intumescent (black) foam off-cuts, or FyreFLEX® Sealant.

[Click to Watch Installation Video](#)



INSTALLATION SuperSTOPPER® Square Mini in Walls

ALL WALLS



TWRAP

Where required, wrap the services with the appropriate length of TWRAP (per FRL tables above). The TWRAP should overlap itself around the entire penetration by 50mm, if two strips are required to meet the appropriate length, then where the second length meets the first, a 50mm overlap is required.

TWRAP is secured to the service using steel cable ties, 50mm from each end and 150mm centres in-between.



LABELLING

Document the penetration. It is general good practice to take photographs and label all completed penetration works to add to the site's documentation for future inspections. AS4072 includes some recommendations and templates for penetration register stickers.

If you need penetration stickers, we offer them at Trafalgar. Click [here](#).

TABLE 1: FIXINGS FyreBOX Maxi & Mini

Wall Type	Fixing
Plasterboard walls, Corex and shaft walls	8gx50mm plasterboard screws
AAC panel (Hebel®, Walsc® etc)	
FyreBOARD Maxilite®	
Speedpanel®	8gx50mm metal drilling head screws
Concrete/Masonry and Alpha Panel	M6x50mm masonry anchors
Plasterboard Ceilings	10gx 100mm plasterboard screws, and additional framing (refer to page 30-31)

INSTALLATION

SuperSTOPPER® Square Mini

CEILING

CUT HOLE



Cut the appropriately sized hole in the ceiling (5-20mm annular gap). FyreBOX can be unhinged to fit around existing services.

THICKEN

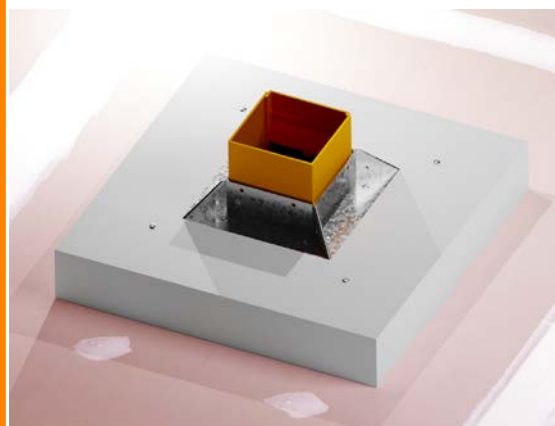

Install 60mm thick Maxilite board to the top side of the penetration around the FyreBOX with 100mm overlaps on all sides. Fix in place with 10gx100mm screws.

Please note: When cutting a hole in any floor for a SuperSTOPPER®, allow for a 5-20mm gap between the box and the edge of the hole.

FLANGES

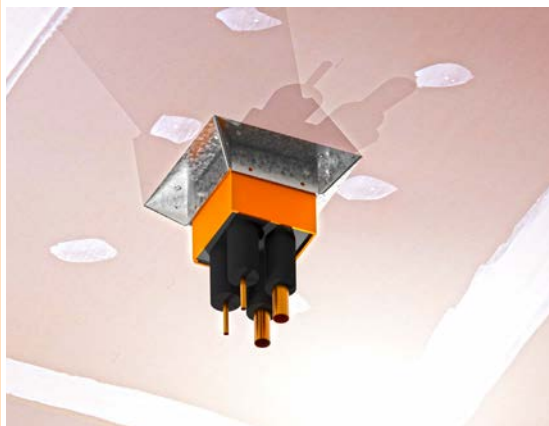

Seal the gaps with FyreFLEX sealant and install both the upper and lower flanges, fixing in place with 10gx100mm screws.

FOAM

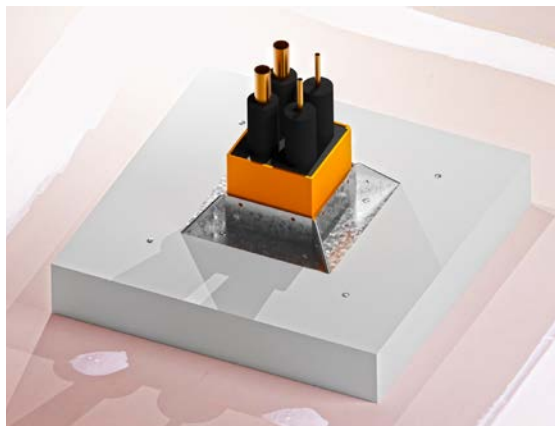

Cut a slit through the FyreBOX foam plug inserts and notch out holes to suit the services that are installed, then fit the foam in the box around the services on the top side only.

The fit should be snug, fill any gaps with foam off-cuts or FyreFLEX® Sealant.

INSTALLATION

SuperSTOPPER® Square Mini in Ceilings

CEILING



Where required, wrap the services with the appropriate length of TWRAP (per FRL tables above) on the top side only. The TWRAP should overlap itself around the entire penetration by 50mm, if two strips are required to meet the appropriate length, then where the second length meets the first, a 50mm overlap is required.

TWRAP is secured to the service using steel cable ties, 50mm from each end and 150mm centres in-between.



Document the penetration. It is general good practice to take photographs and label all completed penetration works to add to the site's documentation for future inspections. AS4072 includes some recommendations and templates for penetration register stickers.

If you need penetration stickers, we offer them at Trafalgar. Click [here](#).

TABLE 1: FIXINGS

FyreBOX Maxi & Mini

Wall Type	Fixing
Plasterboard walls, Corex and shaft walls	8gx50mm plasterboard screws
AAC panel (Hebel®, Walsc® etc)	
FyreBOARD Maxilite®	
Speedpanel®	8gx50mm metal drilling head screws
Concrete/Masonry and Alpha Panel	M6x50mm masonry anchors
Plasterboard Ceilings	10gx 100mm plasterboard screws, and additional framing (refer to page 30-31)

INSTALLATION

SuperSTOPPER® Square Mini in Floors

FLOORS

CUT HOLE



Cut a hole in the barrier allowing for an appropriate annular gap (5-20mm between the edge of the hole and the walls of the SuperSTOPPER® Square Mini). Example: for a 100mm SuperSTOPPER® Square Mini 100 (MS100), cut a maximum hole 140mm diameter.

Note SuperSTOPPER® Square Mini's do not require openings to be framed with stud or lined

INSERT AND SEAL



Insert the SuperSTOPPER® Square Mini into the hole, and centre it to the floor. NOTE: if barrier is too thick, contact Trafalgar Fire for alternative installations.

Seal the annular gap around the FyreBOX with FyreFLEX® Sealant to 20mm depth, on both sides of the floor.

Please note: When cutting a hole in any floor for a SuperSTOPPER®, allow for a 5-20mm gap between the box and the edge of the hole.

FLANGES



Install the steel mounting flange to just the **top side** of a concrete floor. When fitting the flanges, use the fixings to suit the wall or floor type as per table 1 on [page 24](#), using 2x fixings per flange.

FOAM



Cut a slit through the FyreBOX foam plug inserts and notch out holes to suit the services that are installed, then fit the foam in the box around the services. Foam is only needed on the **top side** of a concrete slab penetration.

The fit should be snug, fill any gaps with intumescent (black) foam off-cuts, or FyreFLEX® Sealant.

[Click to Watch Installation Video](#)



INSTALLATION SuperSTOPPER® Square Mini in Floors

FLOORS



TWRAP

Where required, wrap the services with the appropriate length of TWRAP (per FRL tables above) on the top side only. The TWRAP should overlap itself around the entire penetration by 50mm, if two strips are required to meet the appropriate length, then where the second length meets the first, a 50mm overlap is required.

TWRAP is secured to the service using steel cable ties, 50mm from each end and 150mm centres in-between.



LABELLING

Document the penetration. It is general good practice to take photographs and label all completed penetration works to add to the site's documentation for future inspections. AS4072 includes some recommendations and templates for penetration register stickers.

If you need penetration stickers, we offer them at Trafalgar. Click [here](#).

TABLE 1: FIXINGS FyreBOX Maxi & Mini

Wall Type	Fixing
Plasterboard walls, Corex and shaft walls	8gx50mm plasterboard screws
AAC panel (Hebel®, Walsc® etc)	
FyreBOARD Maxilite®	
Speedpanel®	8gx50mm metal drilling head screws
Concrete/Masonry and Alpha Panel	M6x50mm masonry anchors
Plasterboard Ceilings	10gx 100mm plasterboard screws, and additional framing (refer to page 30-31)

INSTALLATION PROBLEM SOLVER

FyreBOARD Maxilite® PENETRATIONS

BULKHEADS



Where it is not possible to treat penetrations directly at the wall/floor penetration, FyreBOX systems are compatible with FyreBOARD Maxilite® bulkhead systems. Refer to [FyreBOARD Maxilite®](#) technical manuals for more information. For compliance of Maxilite bulkhead systems please refer to report FCO2586.

Please note: All penetrations using FyreBOARD Maxilite® require at least 60mm thickness of board.

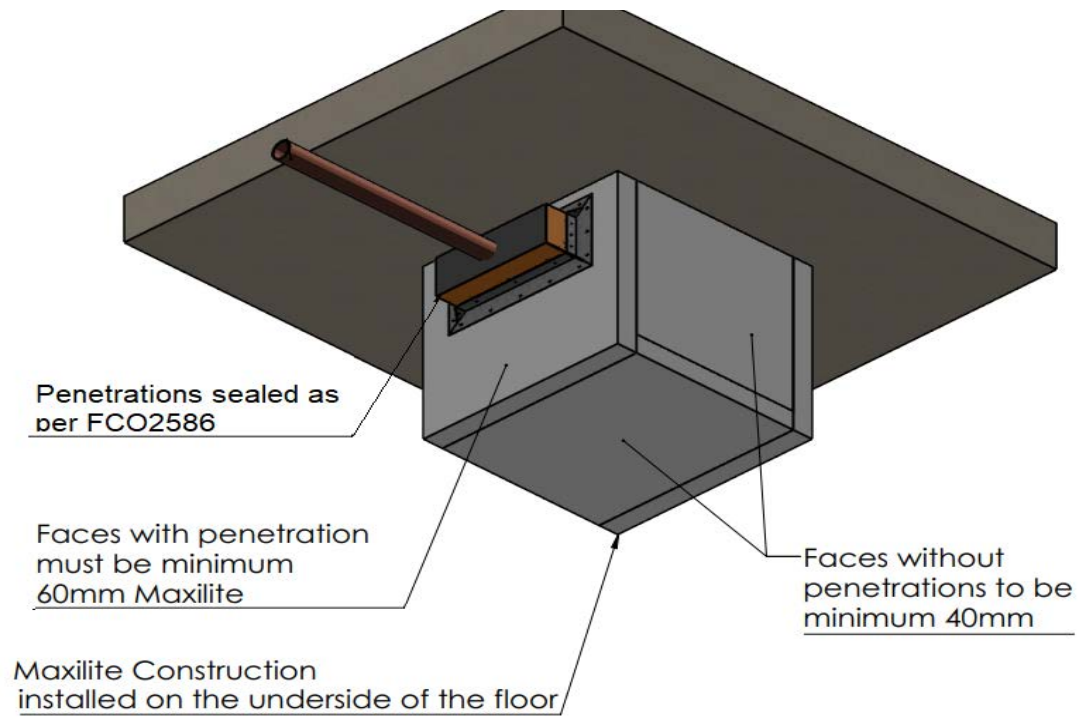

SUPERSTOPPER® SQUARE MINI



COMPLIANCE WITH THE NATIONAL CONSTRUCTION CODE (NCC)

Formerly known as BCA

Under the NCC requirements, a multiple service transit system for service penetrations should be fire tested in every configuration that it is intended for use in, both completely empty (blank seal), partially full and completely full of services so that the product may be installed with as many or as little services as required on site. It is important to fire test in all the different walls types and with different configurations, quantities and types of services which is a time consuming (and expensive) exercise.

Trafalgar Fire SuperSTOPPER systems have been fire tested extensively to AS1530.4-2014 and approved in accordance with Section 4 AS4072.1 as required by Schedule 5 of the NCC. This includes over 200 hours of accredited furnace time and 30 plus individual test reports to cover the full range of service and wall configurations that allow us to comfortably stand behind our multiple SYSTEM approvals.

These configurations include but are not limited to:

- Service fill ratio: Empty (blank seal), half full and completely full of services
- Barrier types: Various types of plasterboard, concrete, Blockwork, Hebel®, Walsc®, Speedpanel®, Pronto panel, FyreBOARD Maxilite® board, concrete floors etc
- Services: Bare and insulated metal pipes and cable bundles, AL and Cu core cables, PVC pipes & conduits, PEX and PEX-AL-PEX pipes, CPVC pipes etc
- Configurations: Blank seal (empty), full of services, double stacked, side by side etc
- Insulation performance: Tested both wrapped and unwrapped with TWRAP to ensure the system works in both configurations
- Penetration sizes: 150 x 125, 350x125, 550x125, 1100x125
- FyreBOX Variants: Slab Mount, Slab Mount Bambino, Cast-in, Maxi and SuperSTOPPER Square Mini and SuperSTOPPER Circular

When choosing a multiple service transit penetration system like FyreBOX, it is important to check that all aspects of your system have been fire tested and are fit for purpose.

Compliance will only be achieved when the installation on site mirrors the tested system.

TEST AND ASSESSMENT REPORTS

The above-mentioned fire testing reports have all been conveniently summarised into **BRANZ assessment report FC10266 (available on www.tfire.com.au)** which neatly tabulates the approved services in a range of fire barriers, for all FyreBOX and SuperSTOPPER variants and applications, and covers only minor variations to the tested systems, thereby providing trouble free certification according to NCC.

Importantly, every aspect of the assessment report are backed up by the fire test data and the individual fire test reports are available on request for certification purposes.

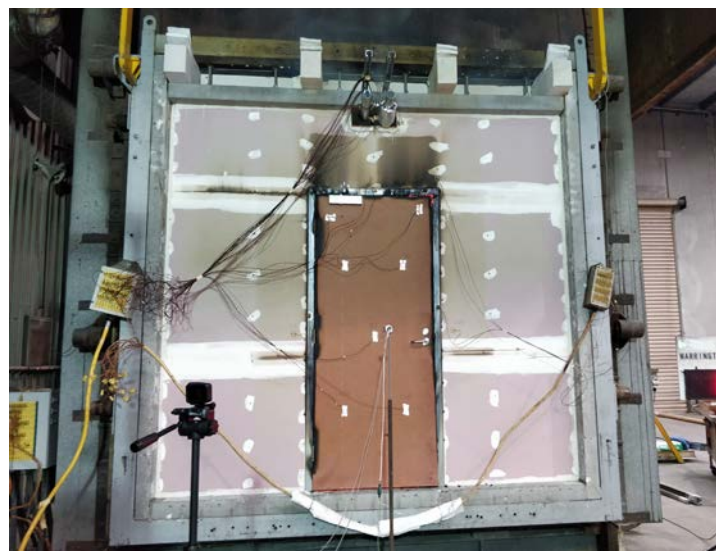

FAQ

Q Is the SuperSTOPPER® Square Mini suitable for my refrigeration lines?

A Yes, the SuperSTOPPER® Square Mini has been tested with both fire resistant (FR) and non-FR insulation and can be filled with as many lines as will reasonably fit in the box.

Q Can I install a SuperSTOPPER® Square Mini after the services have been installed?

A Yes, the SuperSTOPPER® Square Mini has a hinged panel allowing for a retrofit option.

Q My opening is 300 x 600mm. Can I still use a SuperSTOPPER® Square Mini?

A Yes, the opening can be sealed off with Trafalgar Fire's fire rated [FyreBOARD Maxilite®](#) board, and SuperSTOPPER® Square Mini can be mounted in the board. Contact Trafalgar Fire for installation details.

Q My certifier told me I need 2-hour insulation rating on my copper pipe penetrations – does the SuperSTOPPER® Square Mini achieve this?

A TWRAP (or FyreWrap®) will need to be wrapped around the FyreBOX to achieve an insulation rating. Contact Trafalgar Fire for installation details and refer to our YouTube channel for installation videos (Trafalgar TV).

Q Do I need to separate my pipes and cables inside the SuperSTOPPER?

A No, the FyreBOX Range has been fire tested completely full and empty (some trade specific separation may be required).

Q How close together can two FyreBOX be?

A 100mm apart.

Q How far apart other service penetrations need to be from the SuperSTOPPER?

A The NCC references AS 1530.4 2014 which requires 200mm of separation between penetrations during a fire test. Consult your site certifier or surveyor for any reductions on your specific site.

SuperSTOPPER

Click to Watch Installation



FyreBOX MAXI

Click to Watch Installation Video



SOCIAL MEDIA

LinkedIn

YouTube

SuperSTOPPER® Mini (Round or Square) - Annular Gaps

Standard Flange
Up to 5mm annular gaps

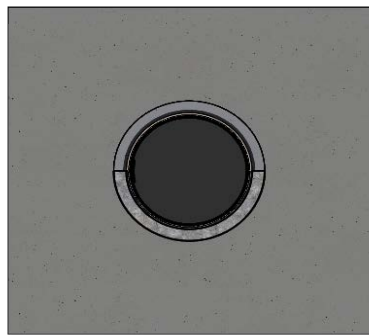
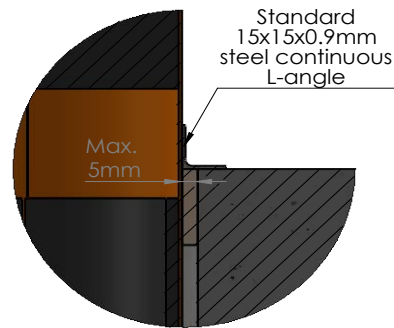

Updated FyreFLANGE™
Up to 20mm annular gaps

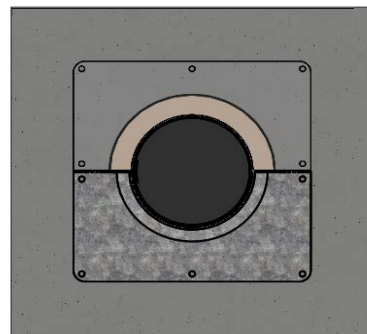
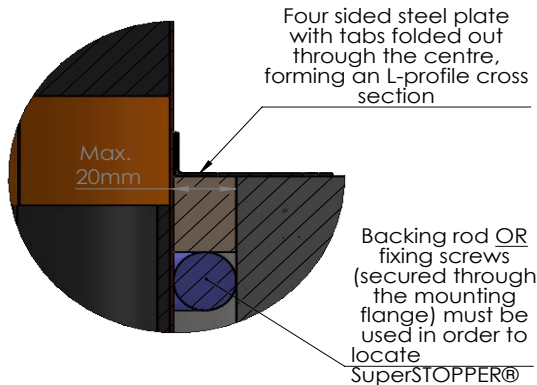

Enlarged Updated FyreFLANGE™
Up to 40mm annular gaps*

*Must follow additional details as outlined in the "Oversized / Scalloped Openings" drawing of this report

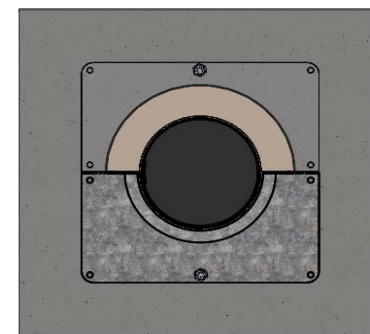
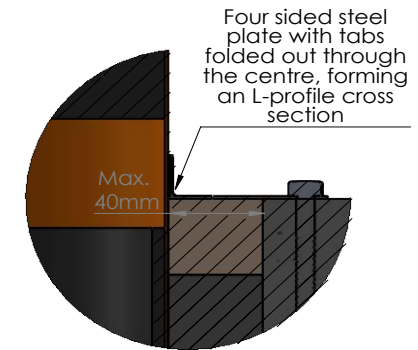

Drawing Name: SuperSTOPPER® Mini Annular Gaps

Test Standard:
AS1530.4

Codes:

Revision:

Date:

No.:

NOTICE:

Project Title: SuperSTOPPER® Mini - Generic Install

Fire resistance level:

Drawn By:
JC

NOTE: ALL DIMENSIONS ARE IN MILLIMETRES (mm)

Drawing No. :
2

Sheet:
2 of 12

Date:
13/07/2020

Scale:
NTS

Based on Report No.:

Checked By:
CT

STANDARD DRAWING
 PROJECT DRAWING



SuperSTOPPER® Mini - Installation Overview

STEP 1

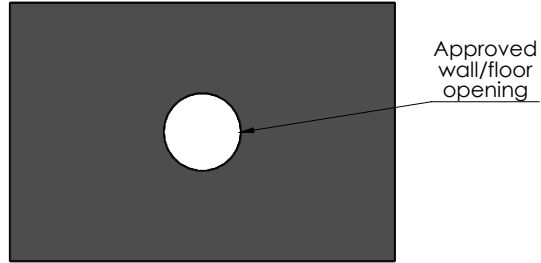

Form opening so that annular gap between SuperSTOPPER® and wall/floor will not exceed 20mm

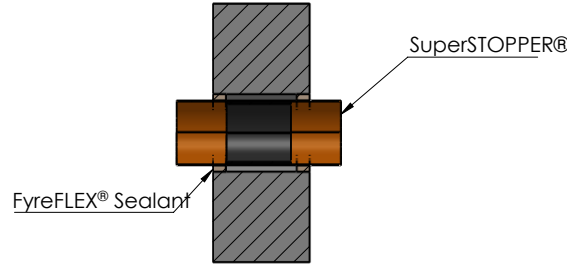

Insert SuperSTOPPER® into opening so that it is central to the thickness of the wall/floor. Fill annular gaps with FyreFLEX® Sealant to a depth of at least 20mm from each side of the barrier.

STEP 3

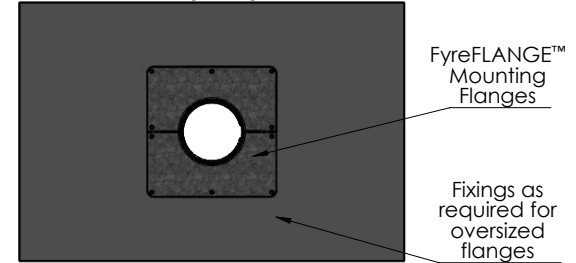

Fit FyreFLANGE™ mounting flanges (as per 'SuperSTOPPER® Mounting Flanges' drawing) around side of the wall/floor, clamping SuperSTOPPER® in place. Secure using the clamping method or optional required

STEP 4

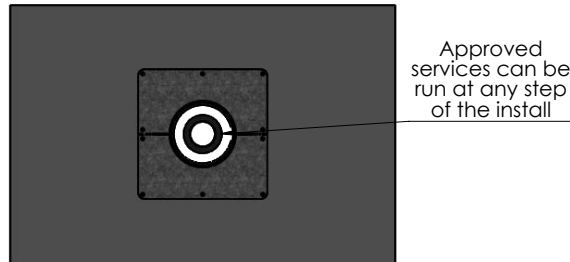

Run approved services through the SuperSTOPPER® opening. Please note, the SuperSTOPPER® Mini has a hinged lid and is also suitable for retrofitting around existing services.

STEP 5

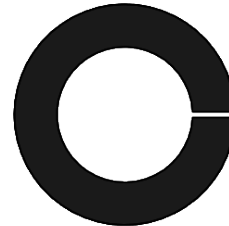

Retrieve foam end plugs and form opening to match the services within the SuperSTOPPER®. Cutting a slit through these openings will allow for the plug to be opened and inserted around the existing services

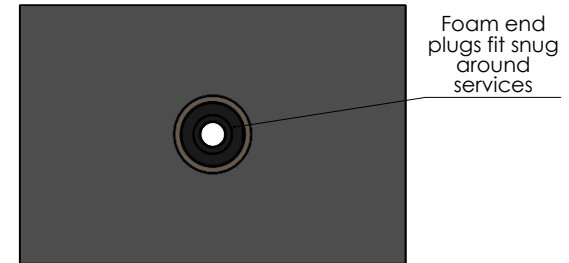

Fit foam end plugs tightly around the services, from each side of the SuperSTOPPER®, and plug any gaps with foam off cuts or FyreFLEX®/FyrePEX HP Sealant. Continue to 'TWRAP™' drawing if wrapping will be required for full insulation.

Approved services can be run at any step of the install

Foam end plugs fit snug around services

NOTE: This is a generic installation guide. For specific details relative to each barrier type, please refer to the corresponding installation drawing as follows.

Drawing Name: Installation Overview				Test Standard: AS1530.4	Codes:	Revision:	Date:	No.:	NOTICE:
Project Title: SuperSTOPPER® - Generic Install				Fire resistance level:	Drawn By: JC	NOTE: ALL DIMENSIONS ARE IN MILLIMETRES (mm)			
Drawing No. : 3	Sheet: 3 of 12	Date: 13/07/2020	Scale: NTS	Based on Report No.:	Checked By: CT				



Concrete / Masonry Walls (with or without permanent formwork)

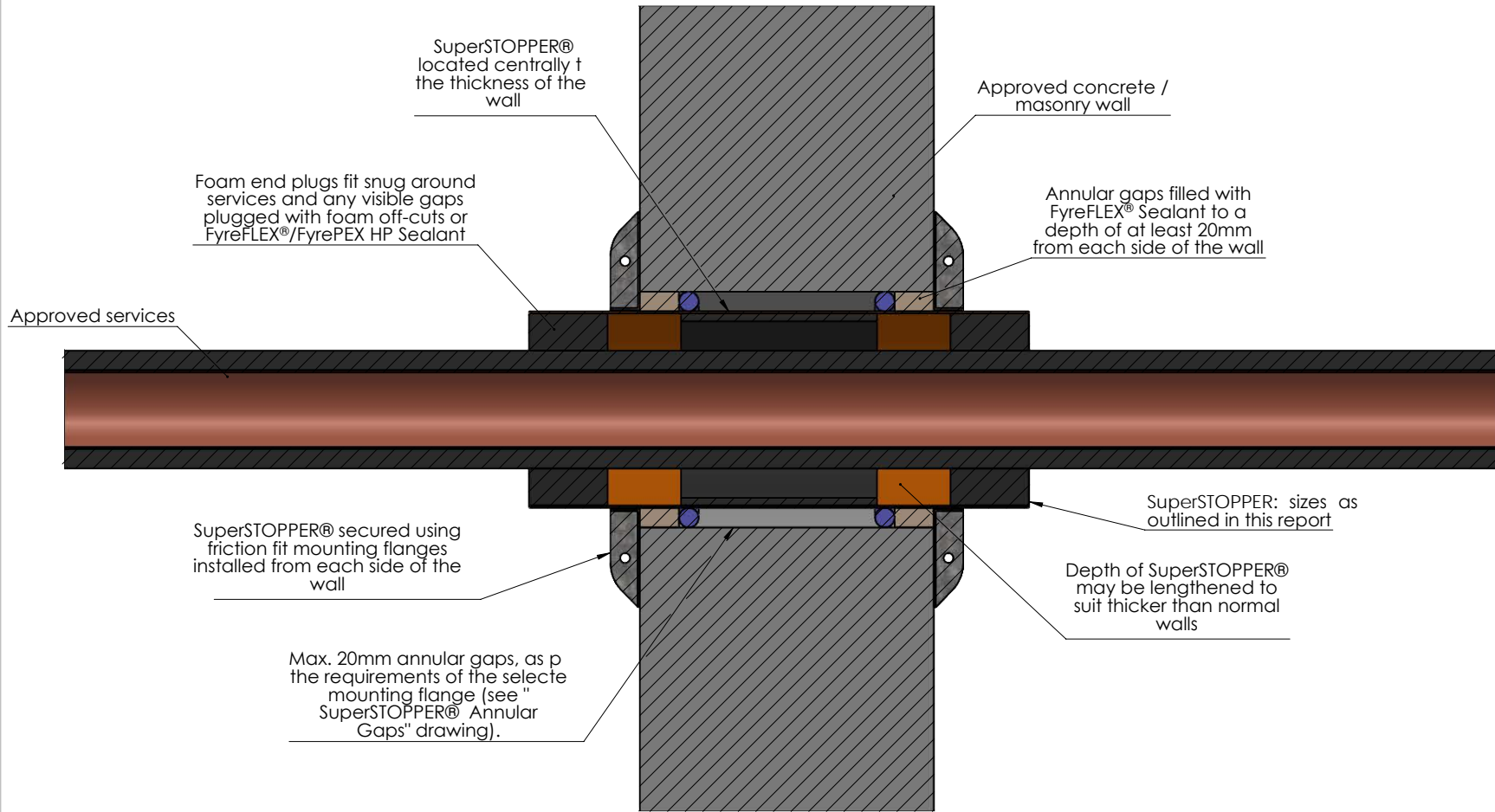

Drawing Name: Concrete / Masonry				Test Standard: AS1530.4	Codes:	Revision:	Date:	No.:	NOTICE:
Project Title: SuperSTOPPER® - Generic Install				Fire resistance level:	Drawn By: JC				<small>NOTE: ALL DIMENSIONS ARE IN MILLIMETRES (mm)</small>
Drawing No. : 4	Sheet: 4 of 12	Date: 13/07/2020	Scale: NTS	Based on Report No.:	Checked By: CT	<input type="checkbox"/> STANDARD DRAWING	<input type="checkbox"/> PROJECT DRAWING		

Plasterboard Walls and Shafts - Plasterboard lined on one side

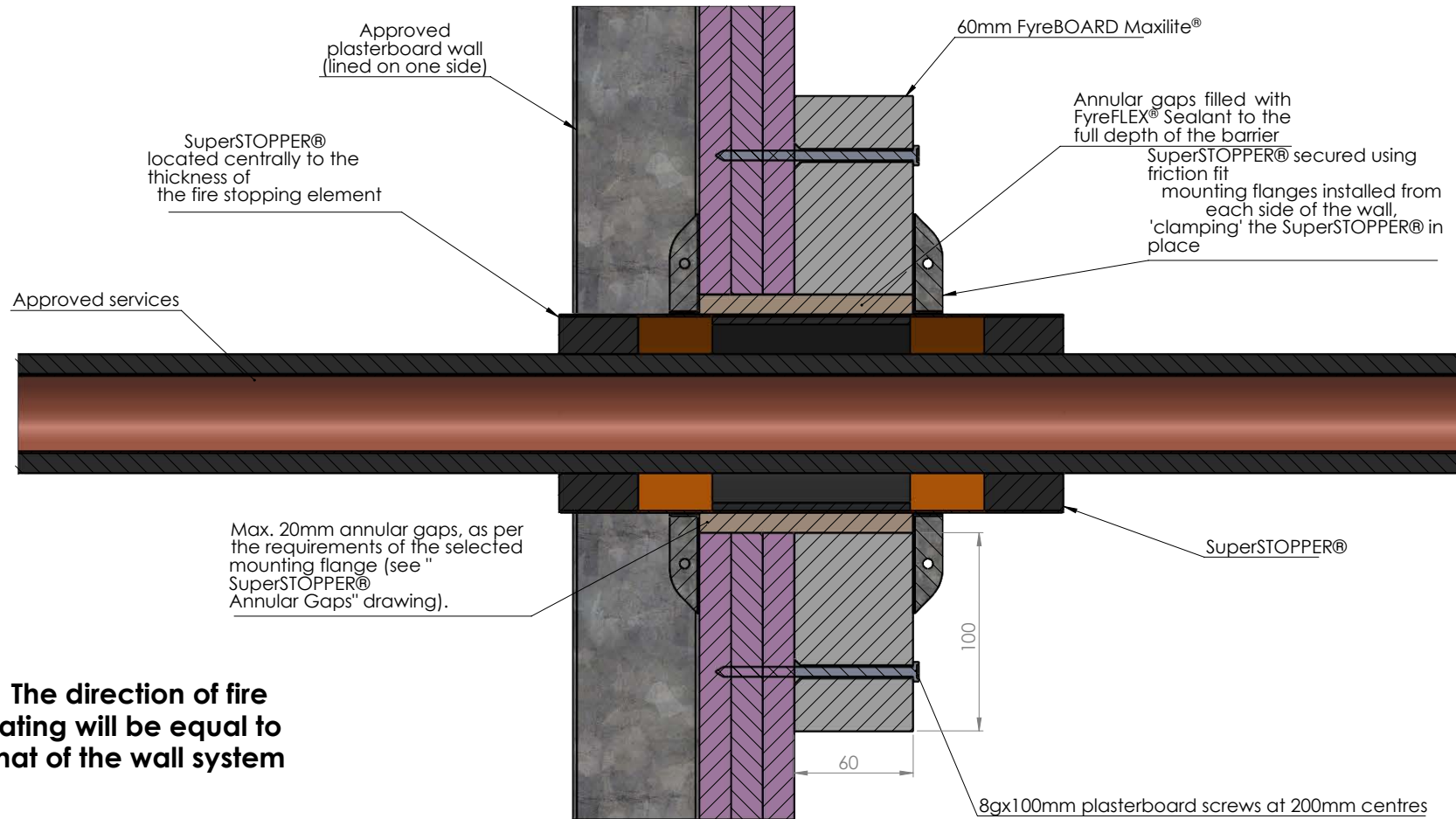

The direction of fire rating will be equal to that of the wall system

NOTE: If TWRAPT™ is to be applied for full insulation, it will only be required in the direction of the fire rating

Drawing Name: Plasterboard - Lined One Side				Test Standard: AS1530.4	Codes:	Revision:	Date:	No.:	NOTICE:
Project Title: SuperSTOPPER® - Generic Install				Fire resistance level:	Drawn By: JC				<small>NOTE: ALL DIMENSIONS ARE IN MILLIMETRES (mm)</small>
Drawing No. : 6	Sheet: 6 of 12	Date: 13/07/2020	Scale: NTS	Based on Report No.:	Checked By: CT	<input type="checkbox"/> STANDARD DRAWING	<input type="checkbox"/> PROJECT DRAWING		

Plasterboard Walls and Shafts - Plasterboard lined on one side

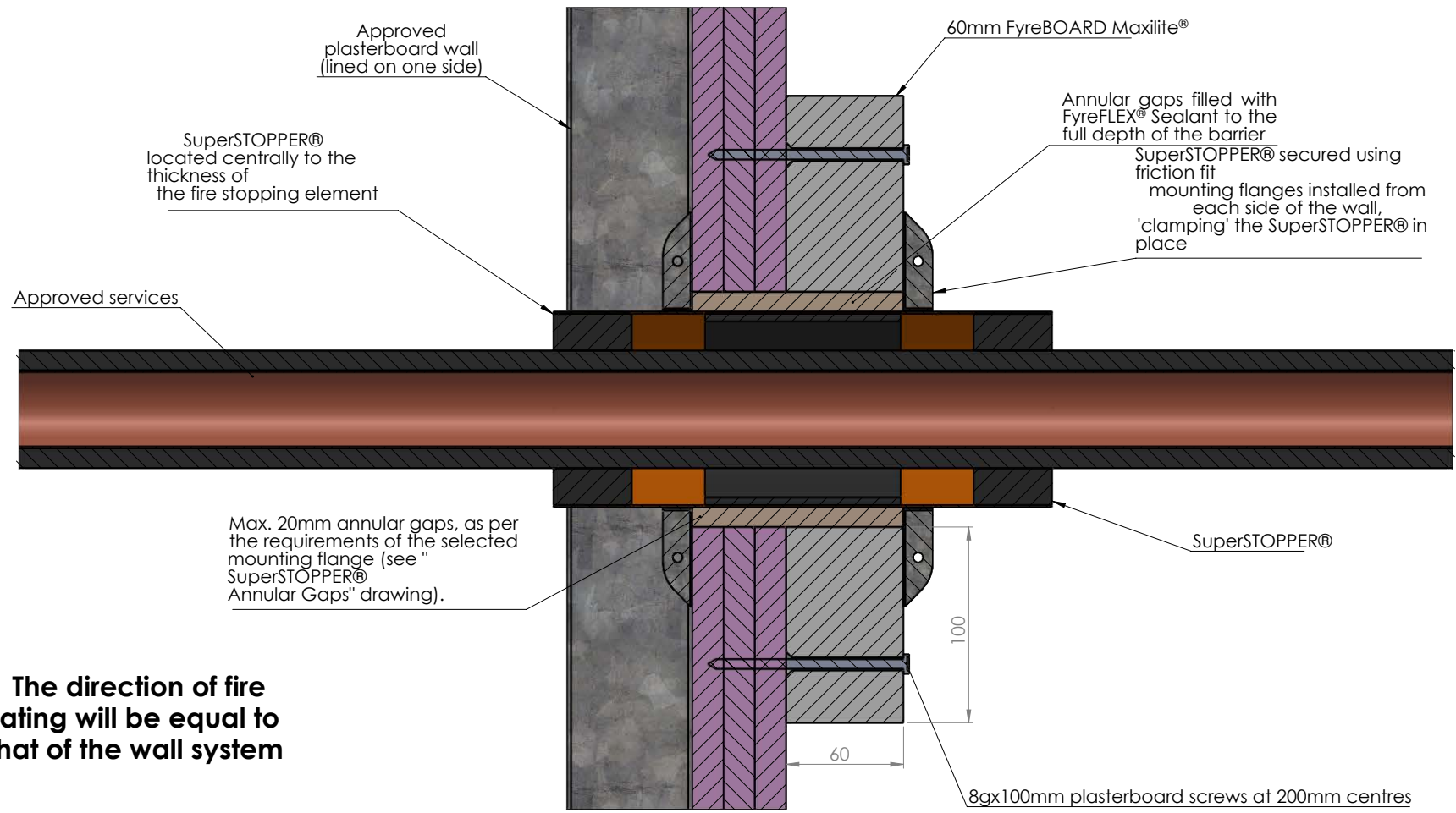

NOTE: If TWRAP™ is to be applied for full insulation, it will only be required in the direction of the fire rating

Drawing Name: Plasterboard - Lined One Side				Test Standard: AS1530.4	Codes:	Revision:	Date:	No.:	NOTICE:
Project Title: SuperSTOPPER® - Generic Install				Fire resistance level:	Drawn By: JC			<small>NOTE: ALL DIMENSIONS ARE IN MILLIMETRES (mm)</small>	
Drawing No. : 6	Sheet: 6 of 12	Date: 13/07/2020	Scale: NTS	Based on Report No.:	Checked By: CT	<input type="checkbox"/> STANDARD DRAWING <input type="checkbox"/> PROJECT DRAWING			

Hebel®/Walsc® AAC Walls

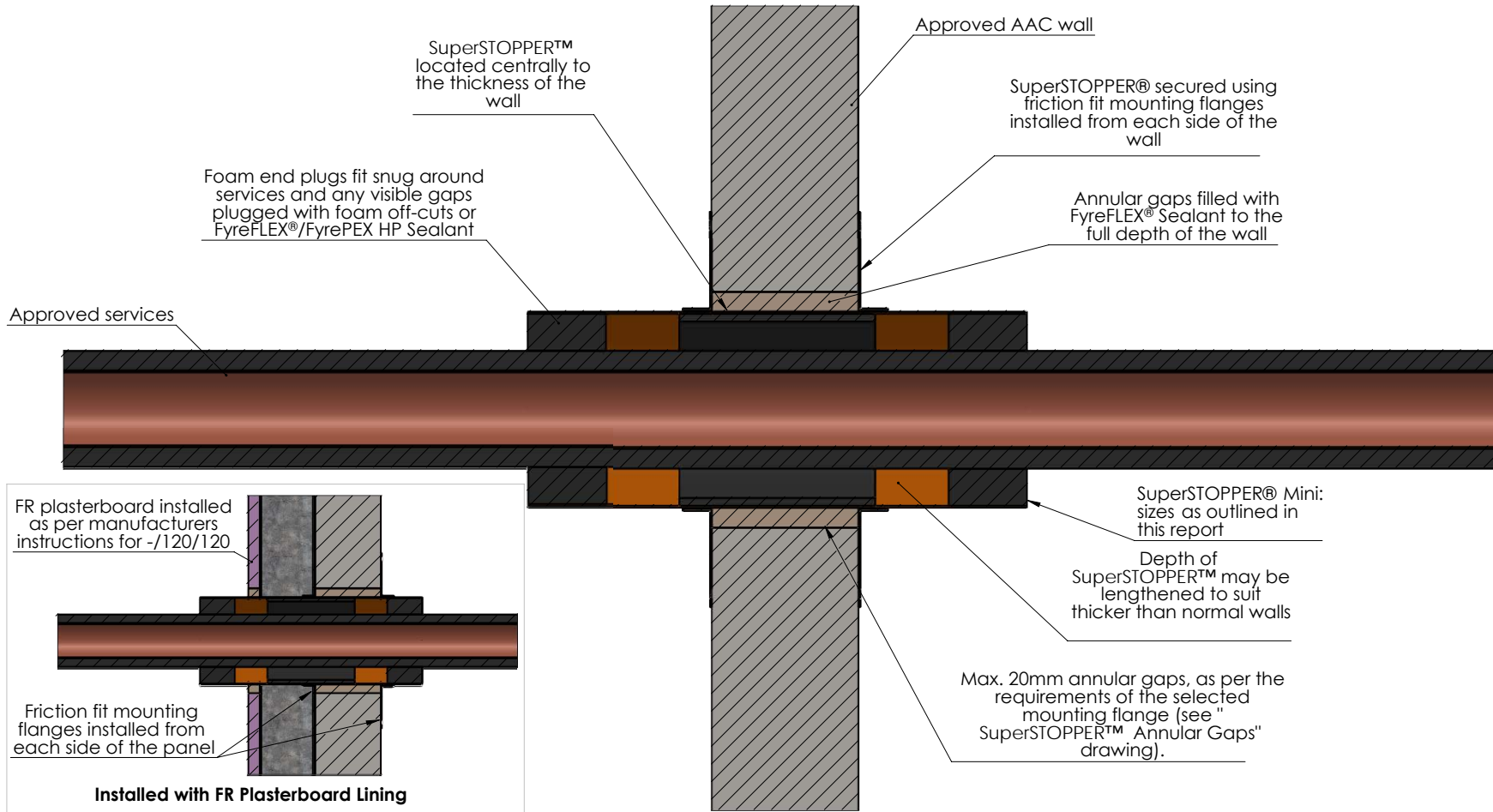

Drawing Name: Hebel®/Walsc® AAC

Project Title: SuperSTOPPER® - Generic Install

Test Standard: AS1530.4	Codes:	Revision:	Date:	No.:	NOTICE:
Fire resistance level:	Drawn By: JC				<small>NOTE: ALL DIMENSIONS ARE IN MILLIMETRES (mm)</small>
Based on Report No.:	Checked By: CT	<input type="checkbox"/> STANDARD DRAWING	<input type="checkbox"/> PROJECT DRAWING		

Drawing No. : 7	Sheet: 7 of 12	Date: 13/07/2020	Scale: NTS
---------------------------	--------------------------	----------------------------	----------------------

Speedpanel® Walls

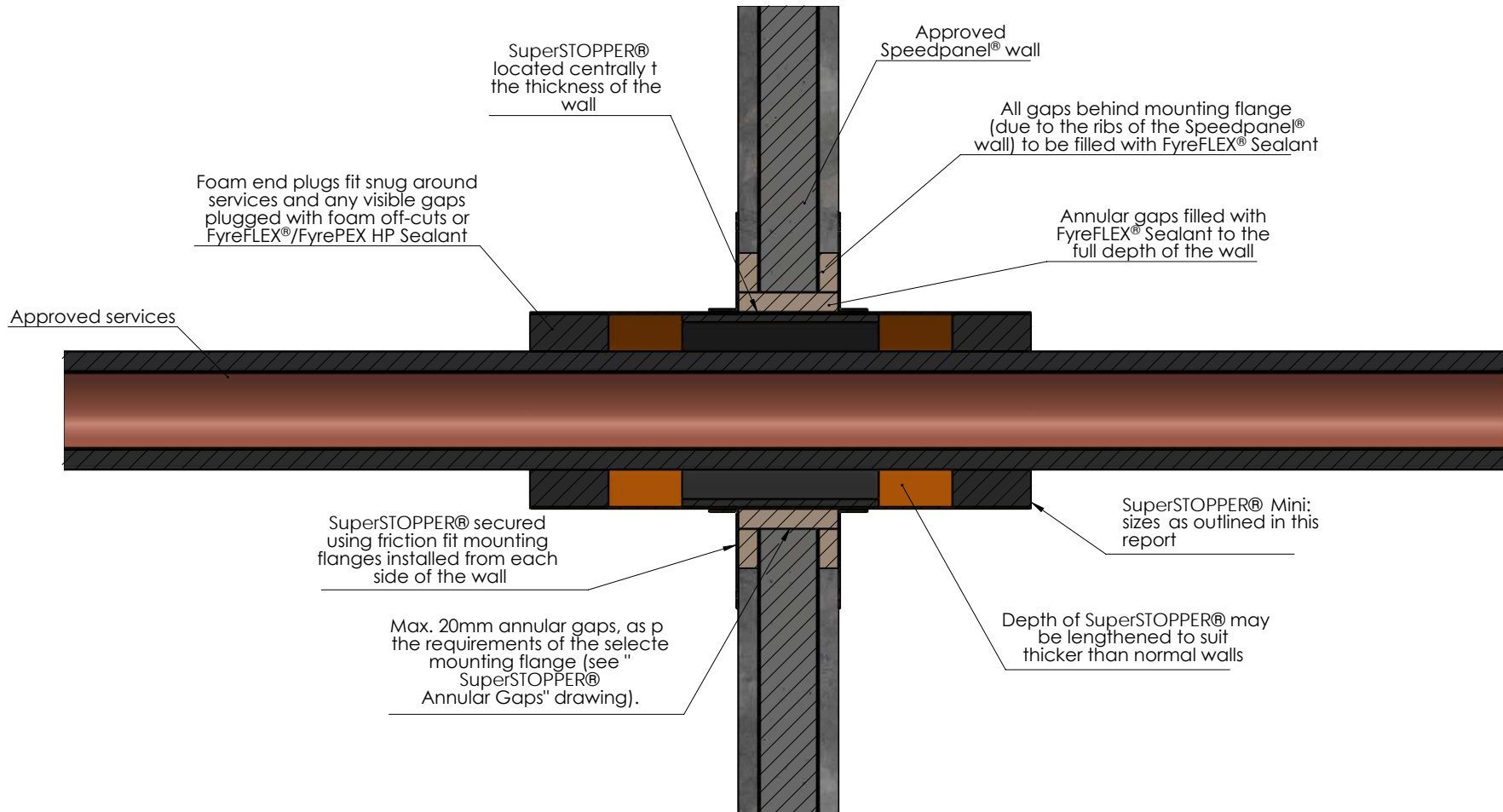

Drawing Name: Speedpanel®				Test Standard: AS1530.4	Codes:	Revision:	Date:	No.:	NOTICE:
Project Title: SuperSTOPPER® - Generic Install				Fire resistance level:	Drawn By: JC				<small>NOTE: ALL DIMENSIONS ARE IN MILLIMETRES (mm)</small>
Drawing No. : 8	Sheet: 8 of 12	Date: 13/07/2020	Scale: NTS	Based on Report No.:	Checked By: CT	<input type="checkbox"/> STANDARD DRAWING <input type="checkbox"/> PROJECT DRAWING			

Concrete Slabs (with or without permanent formwork)

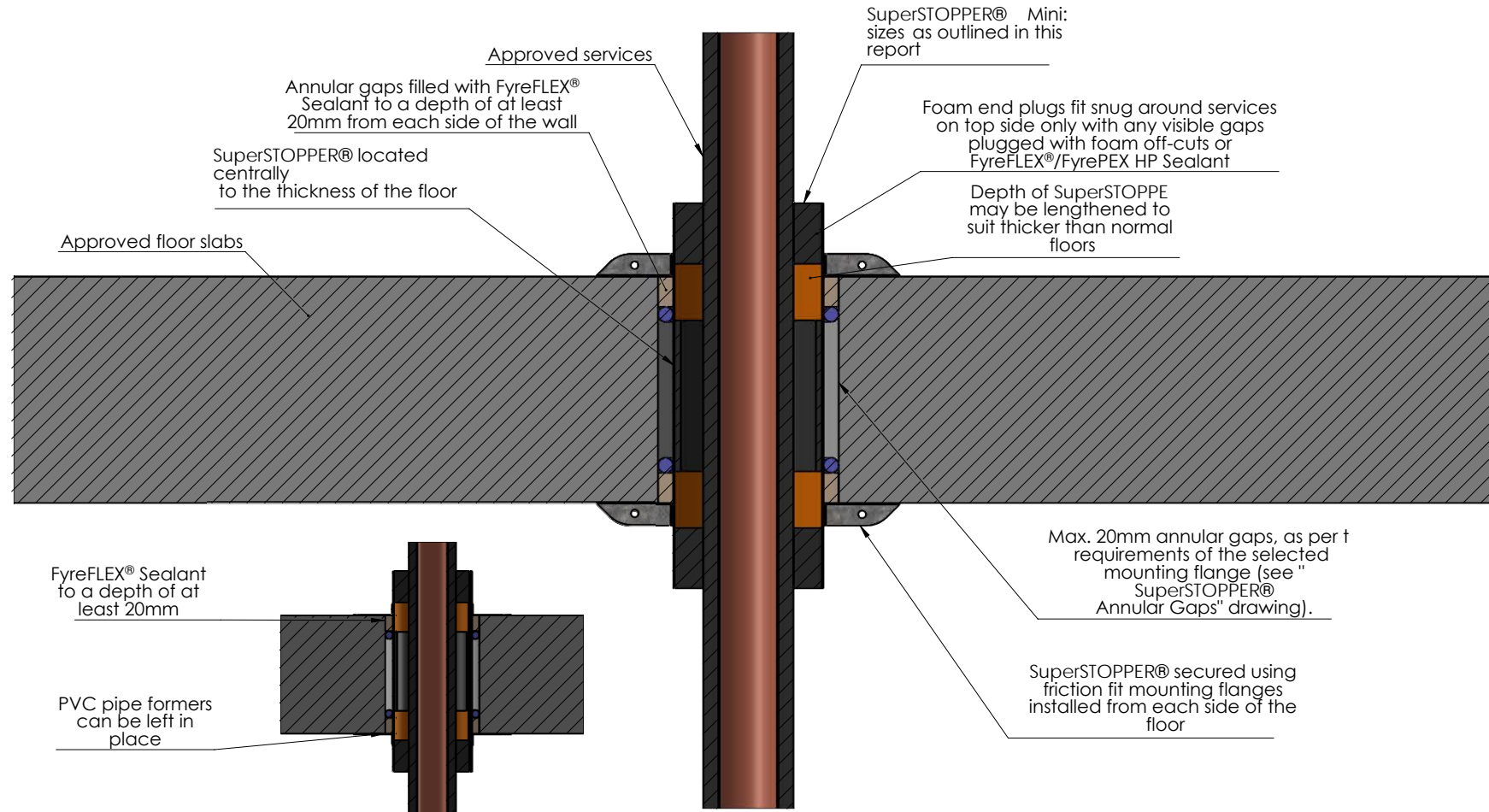

Drawing Name: Concrete Slabs				Test Standard: AS1530.4	Codes:	Revision:	Date:	No.:	NOTICE:
Project Title: SuperSTOPPER® - Generic Install				Fire resistance level:	Drawn By: JC				<small>NOTE: ALL DIMENSIONS ARE IN MILLIMETRES (mm)</small>
Drawing No. : 9	Sheet: 9 of 12	Date: 13/07/2020	Scale: NTS	Based on Report No.:	Checked By: CT	<input type="checkbox"/> STANDARD DRAWING	<input type="checkbox"/> PROJECT DRAWING		

FyreBOARD Maxilite®

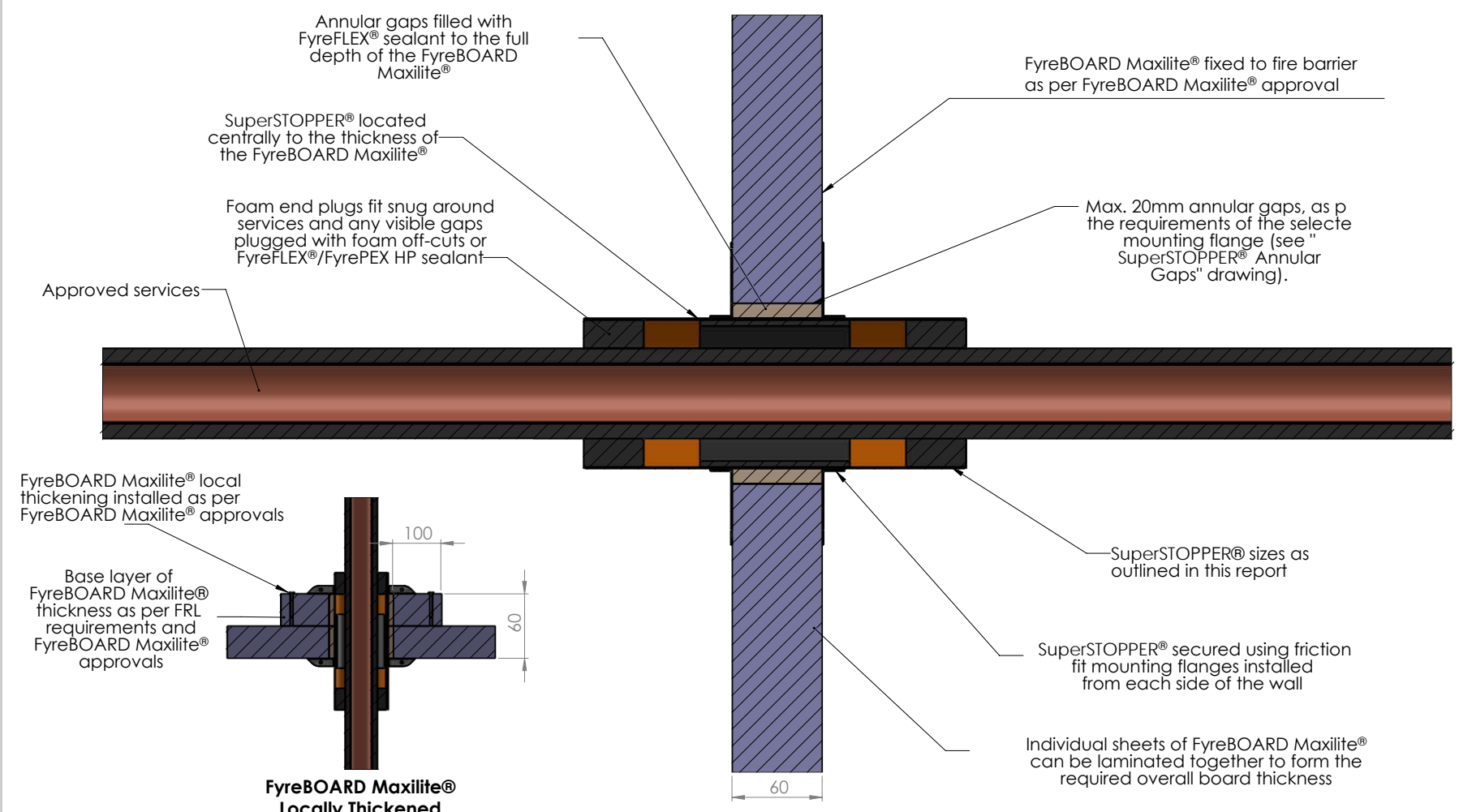

Drawing Name: FyreBOARD Maxilite®				Test Standard: AS1530.4	Codes:	Revision:	Date:	No.:	NOTICE:
Project Title: SuperSTOPPER® - Generic Install				Fire resistance level:	Drawn By: RH	<small>NOTE: ALL DIMENSIONS ARE IN MILLIMETRES (mm)</small>			
Drawing No. : 10	Sheet: 10 of 12	Date: 13/07/2020	Scale: NTS	Based on Report No.:	Checked By: JH	<input type="checkbox"/> STANDARD DRAWING <input type="checkbox"/> PROJECT DRAWING			

TWRAP™ - Fire Rated Walls

Where the SuperSTOPPER® and/or services do not achieve full insulation, TWRAP® can be applied in order to increase this insulation rating up to -/XXX/120.

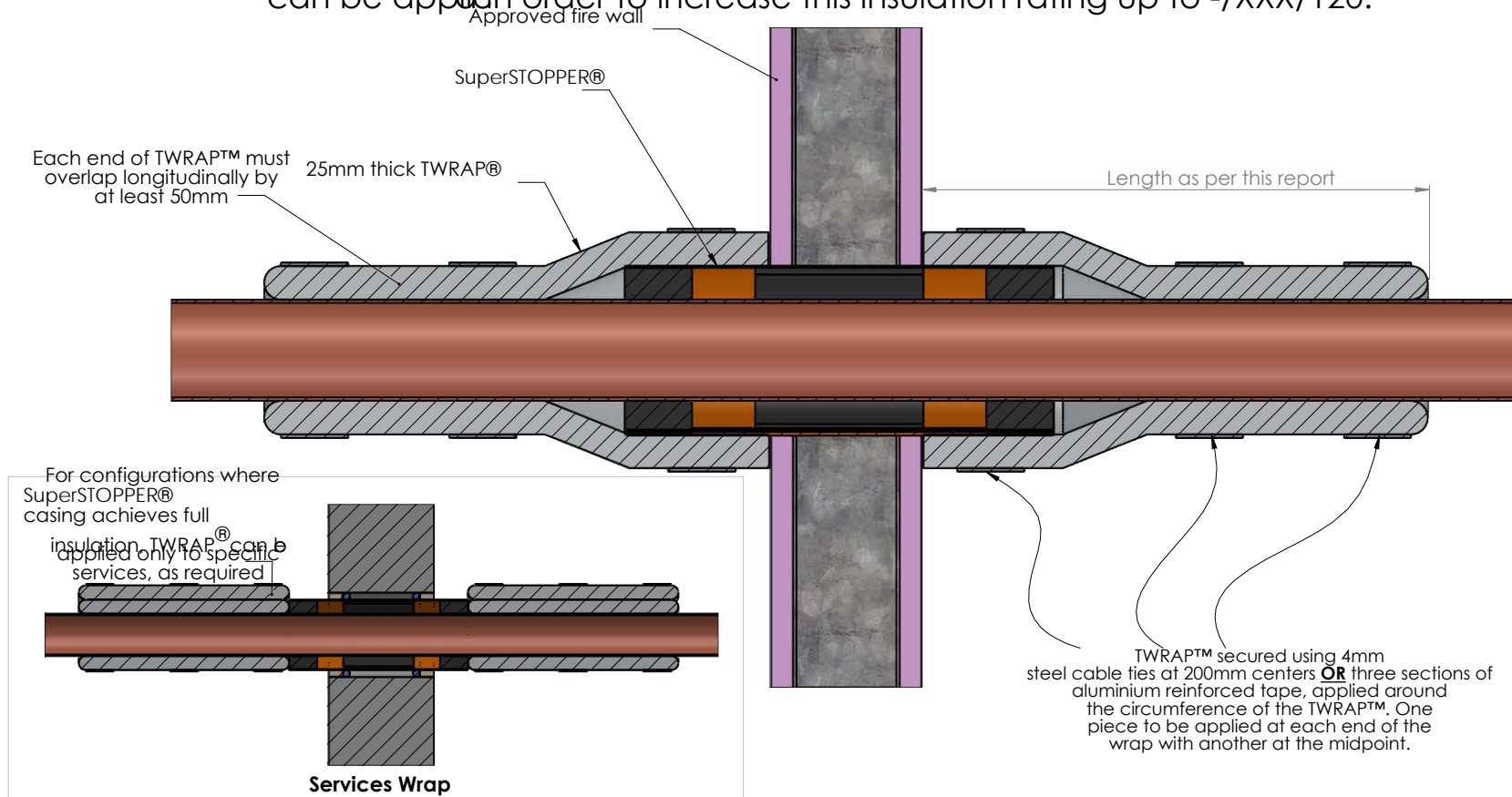

Drawing Name: TWRAP™ - Walls				Test Standard: AS1530.4	Codes:	Revision:	Date:	No.:	NOTICE:
Project Title: SuperSTOPPER® - Generic Install				Fire resistance level:	Drawn By: RH	NOTE: ALL DIMENSIONS ARE IN MILLIMETRES (mm)			
Drawing No. : 11	Sheet: 11 of 12	Date: 13/07/2020	Scale: NTS	Based on Report No.:	Checked By: JH				



TWRAP™ - Fire Rated Floors

Where the SuperSTOPPER® and/or services do not achieve full insulation, TWRAP® can be applied in order to increase this insulation rating up to -/XXX/120.

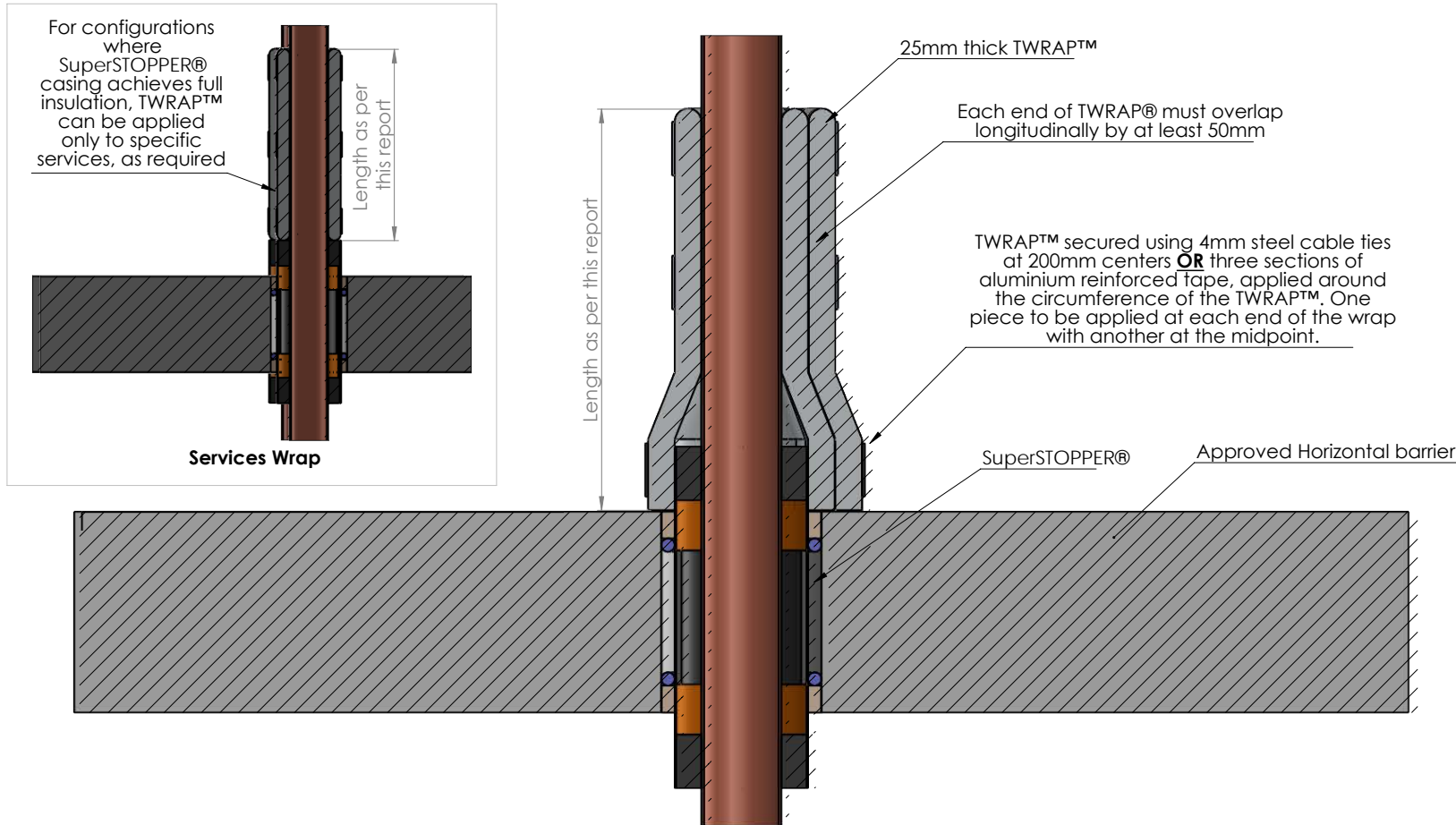

Drawing Name: TWRAP™ - Floors

Test Standard: AS1530.4

Codes:

Revision:

Date:

No.:

NOTICE:

Project Title: SuperSTOPPER® - Generic Install

Fire resistance level:

Drawn By: JC

NOTE: ALL DIMENSIONS ARE IN MILLIMETRES (mm)

Drawing No. : 12

Sheet: 12 of 12

Date: 13/07/2020

Scale: NTS

Based on Report No.:

Checked By: CT

STANDARD DRAWING
 PROJECT DRAWING



Approved fixings

FIXING BETWEEN	FIXING SPECIFICATION (MINIMUM)	ALTERNATE
FyreBOX Slab-Mount and concrete slab	6mm expanding masonry bolt	4mm Hilti MX nails 6mm screw-type masonry anchors
FyreFLANGETM mounting flange and plasterboard	40mm laminating screw	8g x 50mm screws (into studwork)
SuperSTOPPER® and FyreBOX mounting flange and Hebel®/Walsc® AAC	8g x 50mm screws	14g hex-head fixings (as per typical Hebel® specification)
SuperSTOPPER® and FyreBOX mounting flange and Speedpanel®	10g x 25mm self-tapping screws	12-14 x 20mm metal screws
SuperSTOPPER® and FyreBOX mounting flange and concrete/masonry	6mm expanding masonry bolt	6mm screw-type masonry anchors
SuperSTOPPER® and FyreBOX mounting flange and FyreBOARD Maxilite®	8g x 50mm screws	
TWRAPTM and concrete slab (for 3-sided installation)	6mm expanding masonry bolt	4mm Hilti MX nails 6mm screw-type masonry anchors

Notes:

- All fixings used must be all-steel
- Fixings must be compatible with the barriers as outlined in this report, or as-tested

Drawing Name: Approved fixings				Test Standard: AS1530.4	Codes:	Revision:	Date:	No.:	NOTICE:
Project Title: SuperSTOPPER® II Variations				Fire resistance level:	Drawn By: JC				<small>NOTE: ALL DIMENSIONS ARE IN MILLIMETRES (mm)</small>
Drawing No. : 1	Sheet: 1 of 9	Date: 27/05/2020	Scale: NTS	Based on Report No.:	Checked By: CT	<input type="checkbox"/> STANDARD DRAWING <input type="checkbox"/> PROJECT DRAWING			

SuperSTOPPER® Oversized / Scalloped Openings

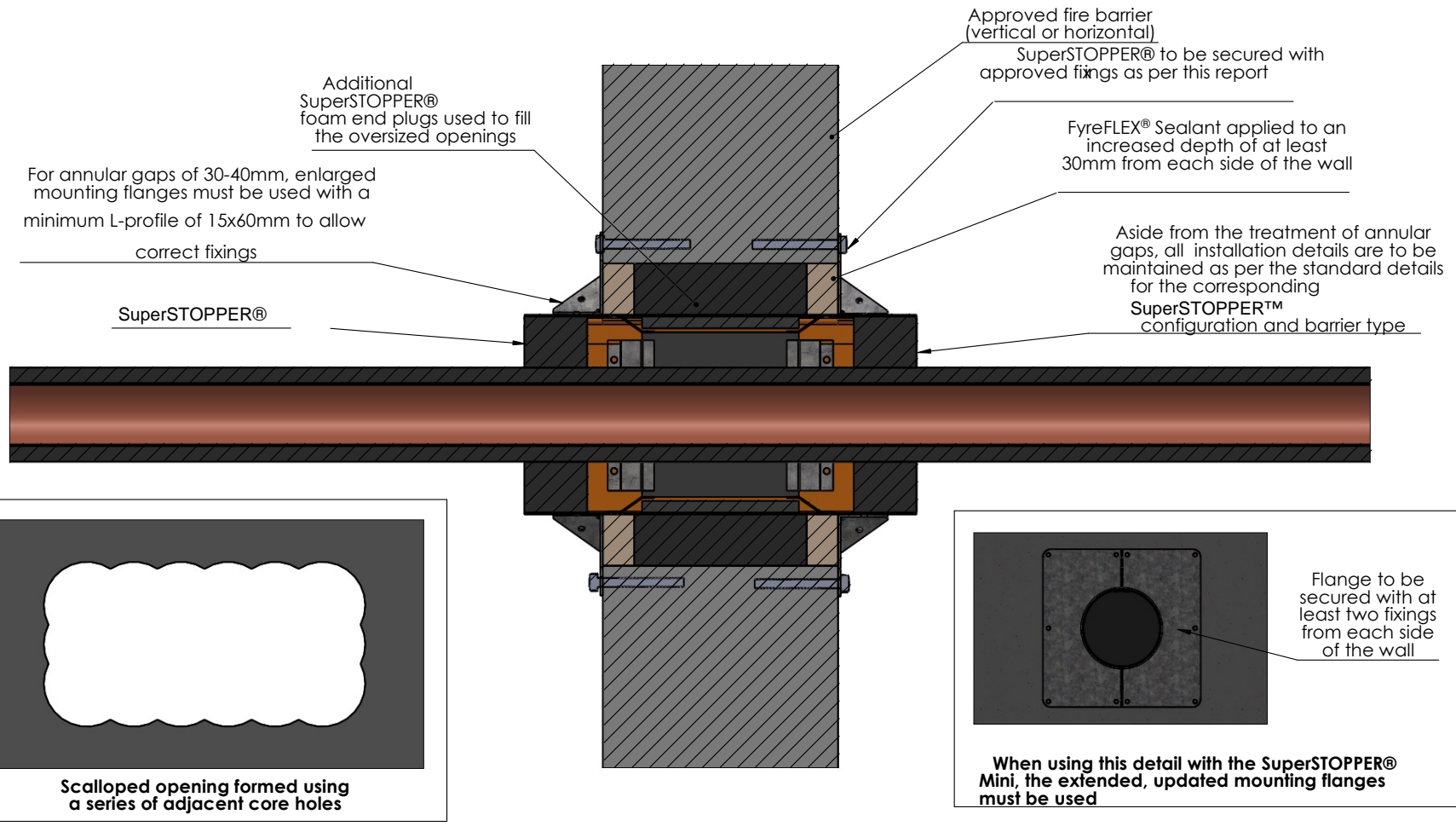

Drawing Name: Oversized / Scalloped Openings				Test Standard: AS1530.4	Codes:	Revision:	Date:	No.:	NOTICE:
Project Title: SuperSTOPPER®				Fire resistance level:	Drawn By: JC				<small>NOTE: ALL DIMENSIONS ARE IN MILLIMETRES (mm)</small>
Drawing No. : 4	Sheet: 4 of 9	Date: 27/05/2020	Scale: NTS	Based on Report No.:	Checked By: CT	<input type="checkbox"/> STANDARD DRAWING			
						<input type="checkbox"/> PROJECT DRAWING			

All SuperSTOPPER® Variants - Bottom Mounting Flange and Foam End Plug Removed

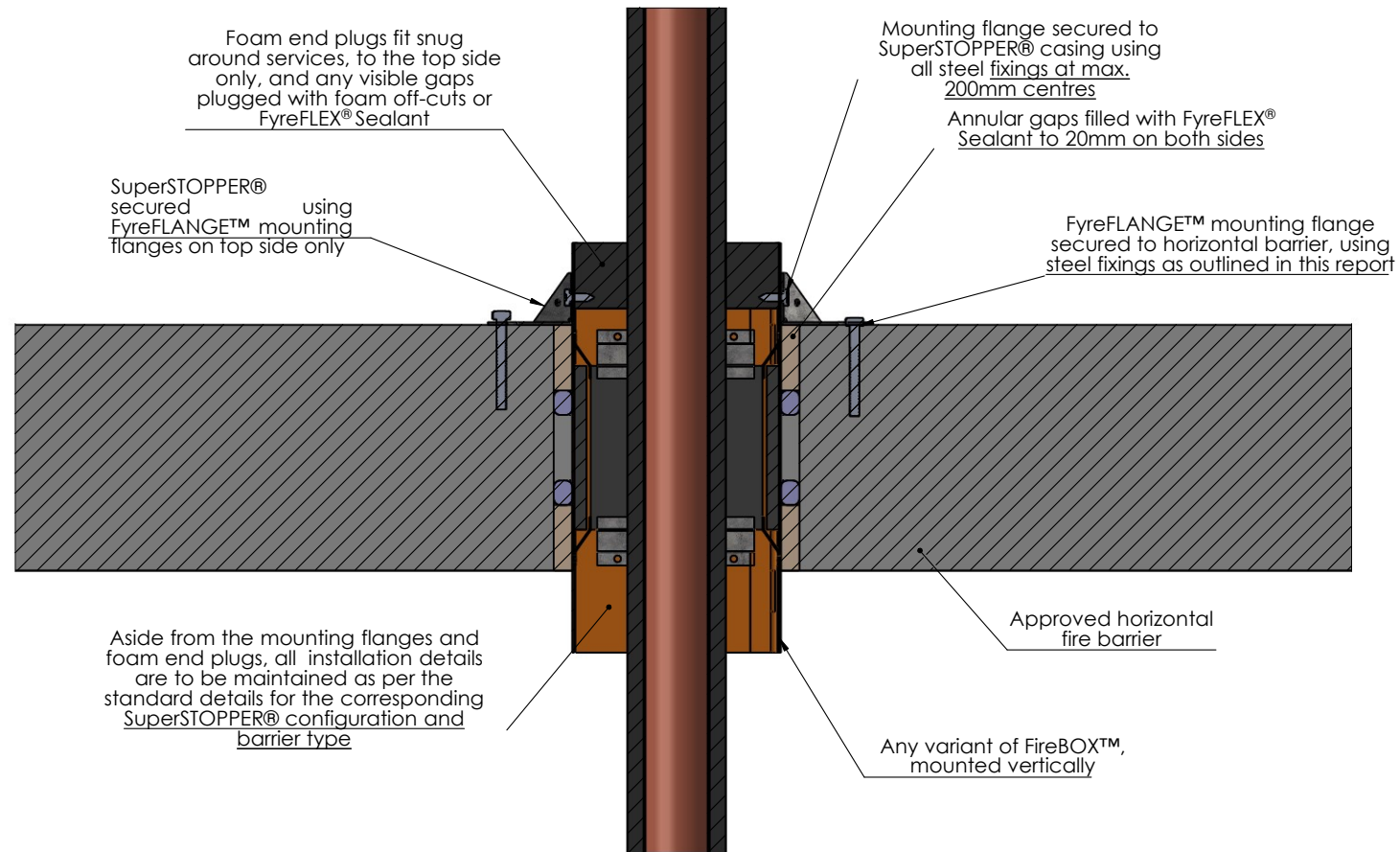

NOTE: Mounting flanges are not required for FyreBOX Slab-Mount or FyreBOX Cast-In, as per standard installation details

Drawing Name: Bottom Foam and Flange Removed				Test Standard: AS1530.4	Codes:	Revision:	Date:	No.:	NOTICE:
Project Title: SuperSTOPPER® Install Variations				Fire resistance level:	Drawn By: JC				<small>NOTE: ALL DIMENSIONS ARE IN MILLIMETRES (mm)</small>
Drawing No. : 5	Sheet: 5 of 9	Date: 27/05/2020	Scale: NTS	Based on Report No.:	Checked By: CT	<input type="checkbox"/> STANDARD DRAWING <input type="checkbox"/> PROJECT DRAWING			

All SuperSTOPPER® Variants - Wrapped Casing

Where the SuperSTOPPER® configuration does not achieve 120 minutes insulation in a given fire barrier, TWRAP® can be applied to the exposed SuperSTOPPER® casing and mounting flanges in order to increase this insulation rating up to - /XXX/120. This applies to the insulation rating of the SuperSTOPPER® only and the insulation rating of individual services may need to be addressed separately.

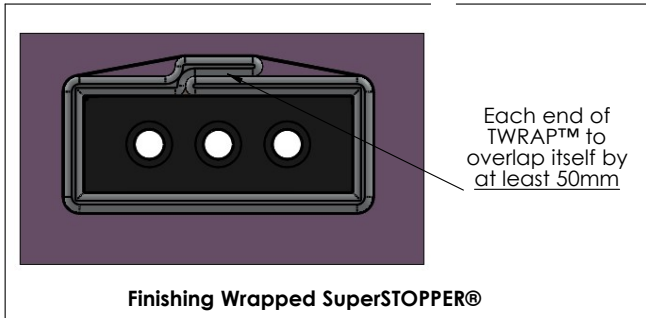
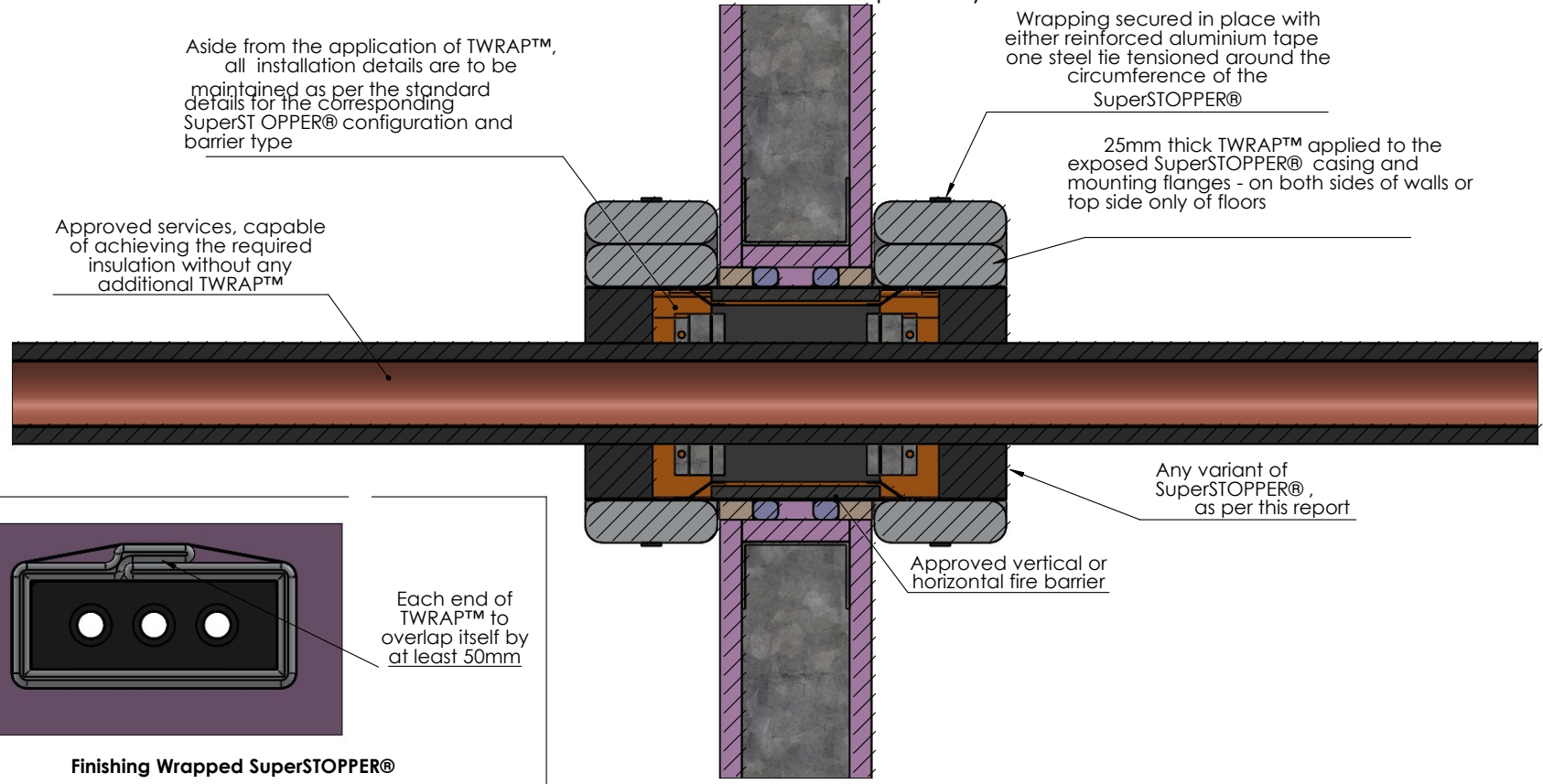

Drawing Name: Wrapped Casing				Test Standard: AS1530.4	Codes:	Revision:	Date:	No.:	NOTICE:
Project Title: SuperSTOPPER® Variations				Fire resistance level:	Drawn By: JC	<small>NOTE: ALL DIMENSIONS ARE IN MILLIMETRES (mm)</small>			
Drawing No. : 6	Sheet: 6 of 9	Date: 27/05/2020	Scale: NTS	Based on Report No.:	Checked By: CT	<input type="checkbox"/> STANDARD DRAWING <input type="checkbox"/> PROJECT DRAWING			



All SuperSTOPPER® variants - Chilled Water Pipes

Metal pipes insulated with any material not already approved combustible or not, can be run through the penetration by swapping out a section for any thickness of Rockwool or Nitrile Composite (ie Armaflex) insulation

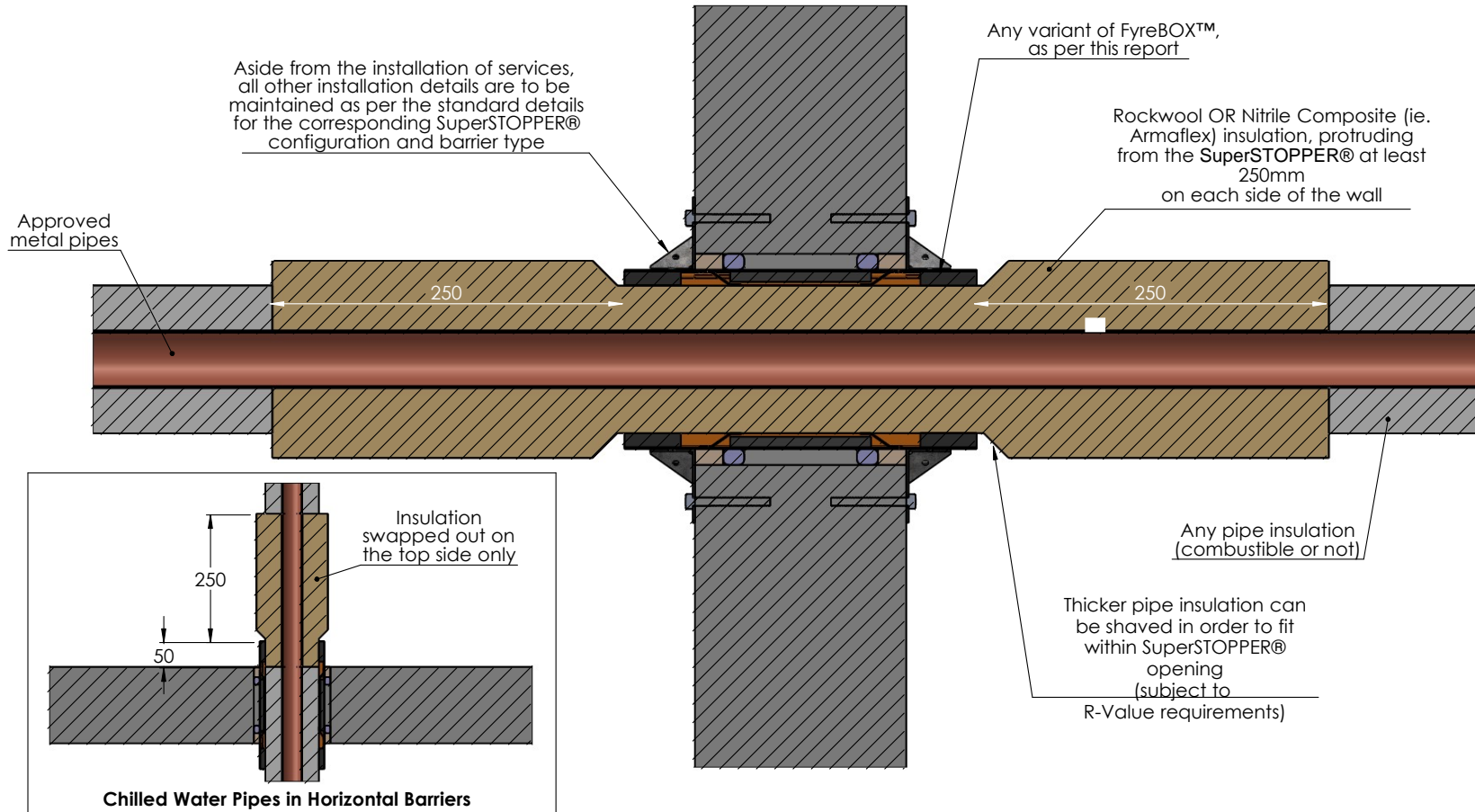

Drawing Name: Chilled Water Pipes

Test Standard:
AS1530.4

Codes:

Revision:

Date:

No.:

NOTICE:

Project Title: SuperSTOPPER® install Variations

Fire resistance level:

Drawn By:
JC

NOTE: ALL DIMENSIONS ARE IN MILLIMETRES (mm)

Drawing No. :
7

Sheet:
7 of 9

Date:
27/05/2020

Scale:
NTS

Based on Report No.:

Checked By:
CT

STANDARD DRAWING
 PROJECT DRAWING



FyreBOX Maxi, SuperSTOPPER® & FyreBOX Cast-In - Installed at any angle

FyreBOX variant to be installed, in approved vertical or horizontal fire barrier, as per standard details relevant to the barrier type.

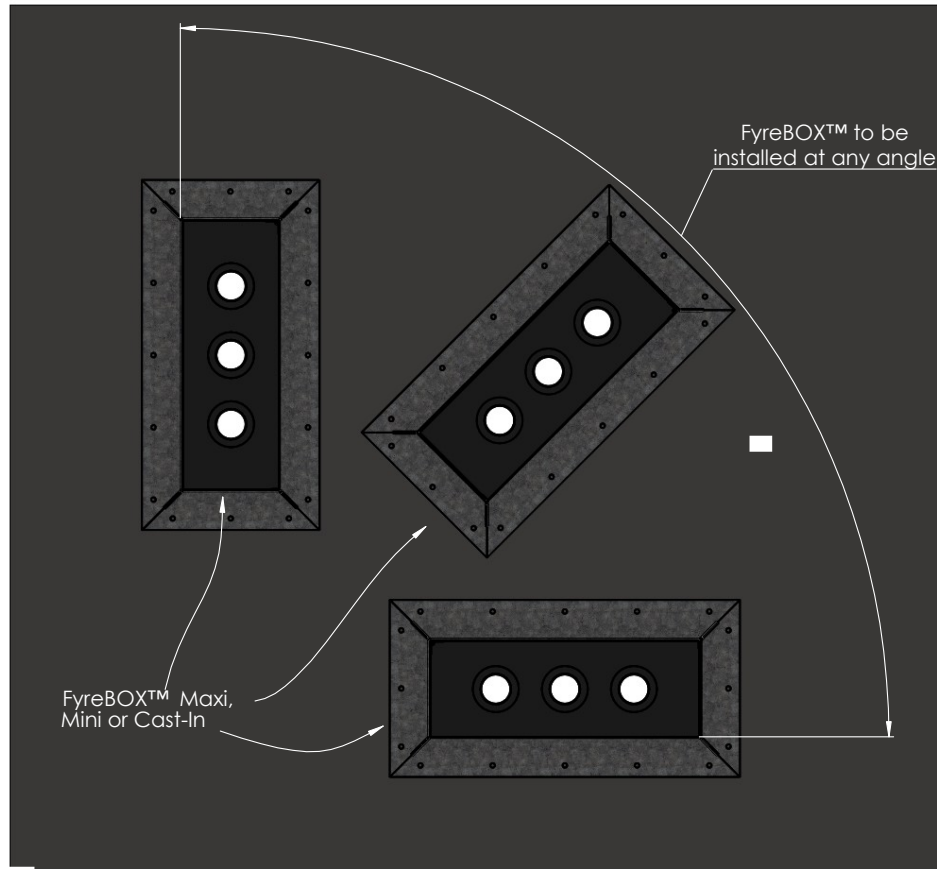

Notes:
Barrier must permit the size and location/orientation of opening
All other installation details as standard

Drawing Name: SuperSTOPPER® At Any Angle				Test Standard: AS1530.4	Codes:	Revision:	Date:	No.:	NOTICE:
Project Title: SuperSTOPPER® Variations				Fire resistance level:	Drawn By: JC				<small>NOTE: ALL DIMENSIONS ARE IN MILLIMETRES (mm)</small>
Drawing No. : 8	Sheet: 8 of 9	Date: 27/05/2020	Scale: NTS	Based on Report No.:	Checked By: CT	<input type="checkbox"/> STANDARD DRAWING			
						<input type="checkbox"/> PROJECT DRAWING			

All SuperSTOPPER® Variants - Centre With FyreBOARD Maxilite®

Note - This installation detail takes the FRL's for FyreBOARD Maxilite® installations

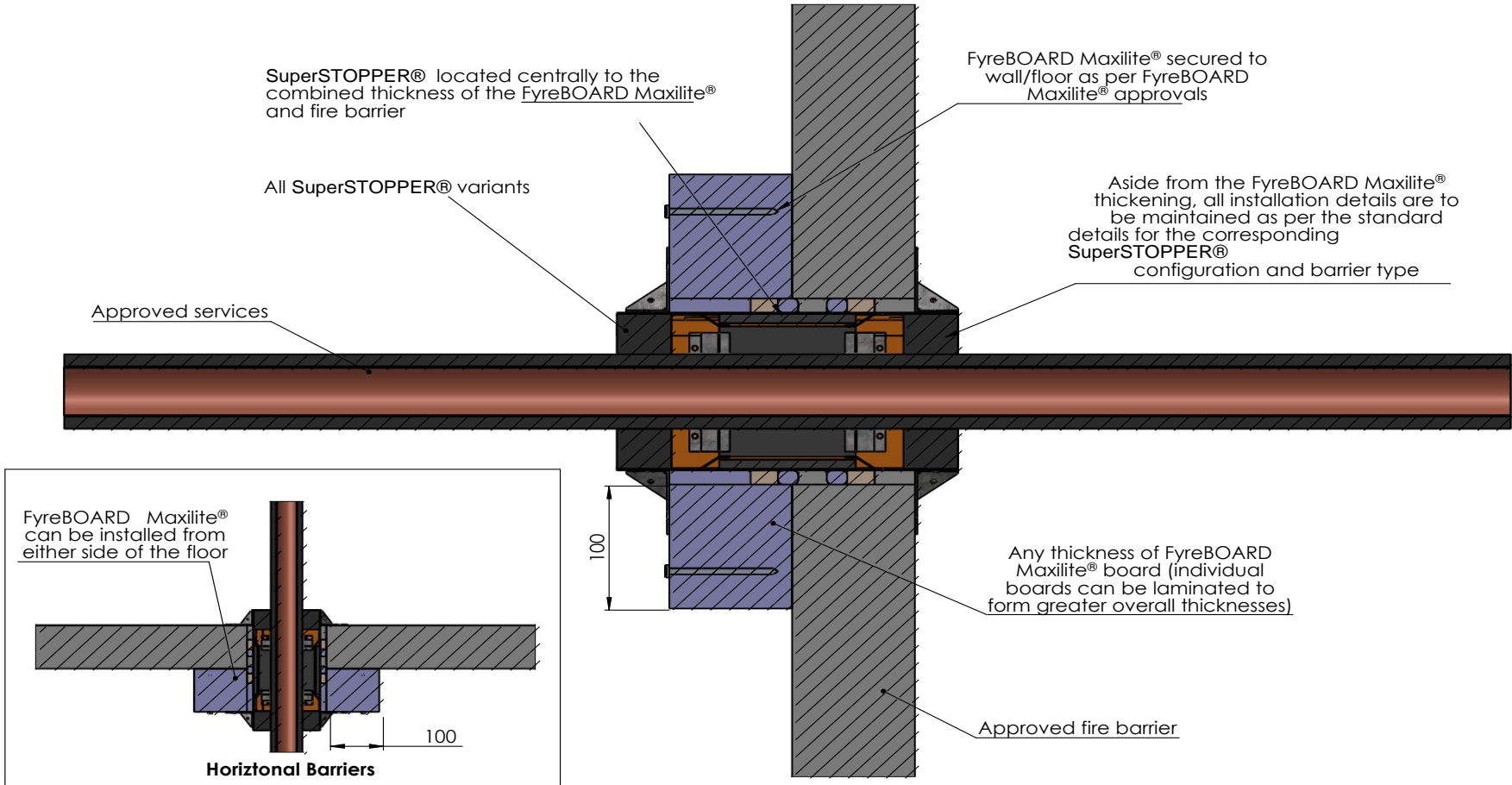

Drawing Name: Centre With FyreBOARD Maxilite®				Test Standard: AS1530.4	Codes:	Revision:	Date:	No.:	NOTICE:
Project Title: SuperSTOPPER® Install Variations				Fire resistance level:	Drawn By: JC	<small>NOTE: ALL DIMENSIONS ARE IN MILLIMETRES (mm)</small>			
Drawing No. : 9	Sheet: 9 of 9	Date: 27/05/2020	Scale: NTS	Based on Report No.:	Checked By: CT	<input type="checkbox"/> STANDARD DRAWING <input type="checkbox"/> PROJECT DRAWING			

